

PEDESTRIAN PRODUCT CATALOGUE 2021



Prices are subject to change. When ordering, please seek a formal quotation from Kersten UK or an Authorised Kersten Dealer.





Contact Us

Director

Chris Faulkner
Tel: 0118 986 9253
Mail: office@kerstenuk.com

Sales and Marketing Manager

Sean Faulkner
Tel: 0118 986 9253
Mail: sales@kerstenuk.com

Parts and Servicing Manager

Douglas Faulkner
Tel: 0118 986 9253
Mail: parts@kerstenuk.com

Accounts Enquiries

Tel: 0118 986 9253
Mail: accounts@kerstenuk.com

Find Us On**Our Website**

<https://kerstenuk.com>

Facebook

<https://www.facebook.com/kerstenuk>

Instagram

<https://www.instagram.com/kerstenuk>

LinkedIn

<https://www.Linkedin.com/kerstenuk>

Twitter

<https://www.twitter.com/kerstenuk>

Please Note

All information on equipment and technical data is non-binding. We reserve the right to make changes regarding further development. All prices quoted are recommended retail prices without VAT. Subject to misprints. Our general terms and conditions apply to all deliveries. These can be viewed in the product catalog or on our website: www.kerstenuk.com. Prices are subject to change. When ordering, please seek a formal quotation from Kersten UK or an Authorised Kersten Dealer.

Our Dealers

Our machines are sold in the UK by our network of dedicated Dealers. Visit the contact us page on our website to find your nearest Dealer.



Contents	Page	Contents	Page
Contact Us	1	SCHNFR Series Snow Blower	69-70
Contents	2	DOME Series Knife Mower	71-72
About KerstenUK	3-4	ZRA Series Rotary Mower	73-74
Integrated Weed Management	5-6	TSM Series Flail Mower	75-76
Weedo II	7-8	SCHLM Series Flail Mower	77-78
K-series Overview	9-10	KRM Series Drum Mower	79-80
K820	11-12	WE Series Gravel Path Renovator	81-82
K820 Pro	13-14	KE Series Power Harrow	83-84
K1500	15-16	ASS Series Seeder	85-86
K2100	17-18	KRB Series Wide Brush	87-88
K-series Attachments Overview	19-20	LBV Series Leaf Blower	89-90
EFKM Series Sweeper	21-22	Hycut Remote Control Mower	91-92
WBK Series Weedbrush	23-24	RCH Series Roughcutter	93-94
Thermhit Series Weed Burner	25-26	Ripagreen Overview	95-96
SCHN Series Snow Plough	27-28	Ripagreen Easy Kit	97-98
SLDST Series Spreader	29-30	Ripagreen Mobility Kit	99-100
DOME Knife Mower	31-32	Ripagreen Easy + Kit	101-102
CM Series Cylinder Mower	33-34	Ripagreen Autonomy Kit	103-104
KRB Series Wide Brush	35-36	Hoaf Infrared Weedburner Overview	105-106
RPB Series Reciprocating Brush	37-38	Thermhit 15	107-108
SULK Sulky Seat	39-40	Thermhit 25	109-110
UBS Series Overview	41-42	Thermhit 45	111-112
UBS Hydro 9	43-44	Weedair 50i	113-114
UBS Hydro II 13	45-46	Thermhit 75	115-116
UBS Hydro II 16	47-48	Weedgo Overview	117-118
UBS Master II 18	49-50	Weedgo 2	119-120
UBS Alpin II 23	51-52	Weedgo Pro	121-122
UBS Comfort Drive	53-54		
UBS Attachment Overview	55-58		
EFKM Series Sweeper	59-60		
WKB Series Weedbrush	61-62		
Thermhit Series Weedburner	63-64		
SCHN Series Snow Plough	65-66		
SLDST Series Spreader	67-68		



Site Maintenance Requires Experience

Kersten is one of the leading manufacturers of site maintenance equipment in Europe. The range includes attachments for a host of vehicles, from ride on mowers and compact tractors to agricultural tractors, Unimog and single-axle vehicles.

Kersten two-wheel tractors are made specifically for grounds maintenance professionals.

The machines are designed for exceptional preventative and remedial care of outdoor surfaces such as tarmac, block paving, artificial grass and gravel. Two wheel tractors have traditionally been used for agricultural and horticultural soil engaging tasks. They generally feature a front engine and rear mounted attachment like a cultivator. Kersten machines are designed with an upright chassis that is perfect for performing tasks on top of hard surfaces. This upright design allows for much greater control of the front mounted attachments such as sweepers, weed brushes, snow ploughs, spreaders and grass cutting equipment.

The Kersten K-series and UBS ranges feature a infinitely adjustable hydraulic transmission which is key to performing tasks like sweeping and weed brushing, as it allows the machine to be slowed to the ideal speed for the application, giving attachments time to achieve the desired cleaning results.

Features such as hydraulic drive, low vibrations, low noise and simple controls make for a machine that is very reliable and easy to use, giving many years of dependable service; even in the most demanding environments.

What Kersten UK Does

Our Mission

To give every ground care professional the tools to make a better world.

Our Aspirations

We can make our world a cleaner and safer place, one ground care professional at a time, by arming them with the tools to make the best job of maintaining their grounds. We take pride in working to become the easiest company to deal with; continually improving our people, our products and our delivery.

Our Products

We strive to deliver the best products for our customers in the areas of weed control, outdoor cleaning, snow and ice management and grass cutting. Our products are sourced from the best industry suppliers and then perfected for the unique demands of our territories.

Our Background

We started importing the Kersten range of sweepers and grounds maintenance equipment from Germany in 2004. The family business is run by Chris Faulkner and involves his two sons, Sean and Douglas, as well as a team of incredible staff. We have the main office in Reading and a satellite office in Scotland. We sell through a network of dedicated Authorised Dealers, to supply the best possible service for our customers.

Warranty

Register your machines for our two year warranty. Available on all the brands we sell.



Kersten manufacture a wide range of site maintenance equipment for weed control, snow clearance, sweeping and mowing. Kersten two wheel tractors are renowned for their high quality and innovative design.



We supply high quality thermal weed control products from ripagreen. The ripagreen thermal lances are an ideal alternative to chemical plant protection products such as glyphosate.



Hoaf are a manufacturer of quality infrared weed control solutions. Providing both stand alone equipment and attachments for Kersten two wheel tractors, Hoaf equipment is adaptable and effective.



If you own a professional brush cutter and have a moss or weed problem the Weedgo can be a brilliant option. Designed to attach to most professional brush cutter models, this tool is perfect for jobs in tight spaces.



Zanon are our latest brand. Sporting a brilliant range of grass cutting attachments for our UBS range adding even more versatility.

Hand Arm Vibration (HAV) on Kersten machines

Vibrations are also known as oscillations or shocks. Their effects on humans can range from annoyance and reduced performance to health hazards and damage to health. Human exposure to vibrations in the workplace can be divided into whole-body and hand-arm vibrations, depending on where they are exposed.

Since July 2002, a European Directive 2002/44 / EC for the protection of employees against harmful vibrations at the workplace has been in force. The trigger value (body-damaging vibration) for hand-arm vibrations is 2.5 m/s^2 , the exposure limit value is 5 m/s^2 , from this value special protective measures are necessary. We have tried to minimise the vibrations on all these machines. Where possible we have noted the bench test figures for each machine. Different figures will be achieved in different applications and by making adjustments to the machines. Therefore your own tests should be carried out on particular applications and investigate the effects of making adjustments on the machine to the HAV levels.

Integrated Weed Management



In recent years there has been a massive shift in the way our customers are looking at weed control. We pride ourselves on being at the forefront of this change - leading the way with new technologies that allow our customers to greatly reduce their dependence on chemical based plant protection products.

We firmly believe that the way to achieve this is through a focus on Integrated Weed Management. The foundation of our approach has been to focus on dealing with the core causes and surface issues that lead to weed growth, rather than simply treat the weeds as a symptom.

Doing so leads to surfaces that are far better cared for and a great reduction in effort and expense over the longer term.

The most important challenge we face on our surfaces is not the weeds themselves, it is the soil cycle (outlined below) that leads to weed growth, poor surface drainage and damage of surfaces. By focusing on this core problem, we can achieve the results you are looking for in a more sustainable way, using chemicals as a last resort.

By Interrupting the soil cycle, we can remove the nutrients that weeds require in order to grow. On many surfaces this involves the remedial task of removing a large build up that has aggregated over several years. Once the large soil buildup is removed from the surface and surrounding areas, the job becomes a simple task of sweeping or removing detritus such as leaves, grass cuttings and other organic debris before it can decompose. A very quick and simple maintenance task.

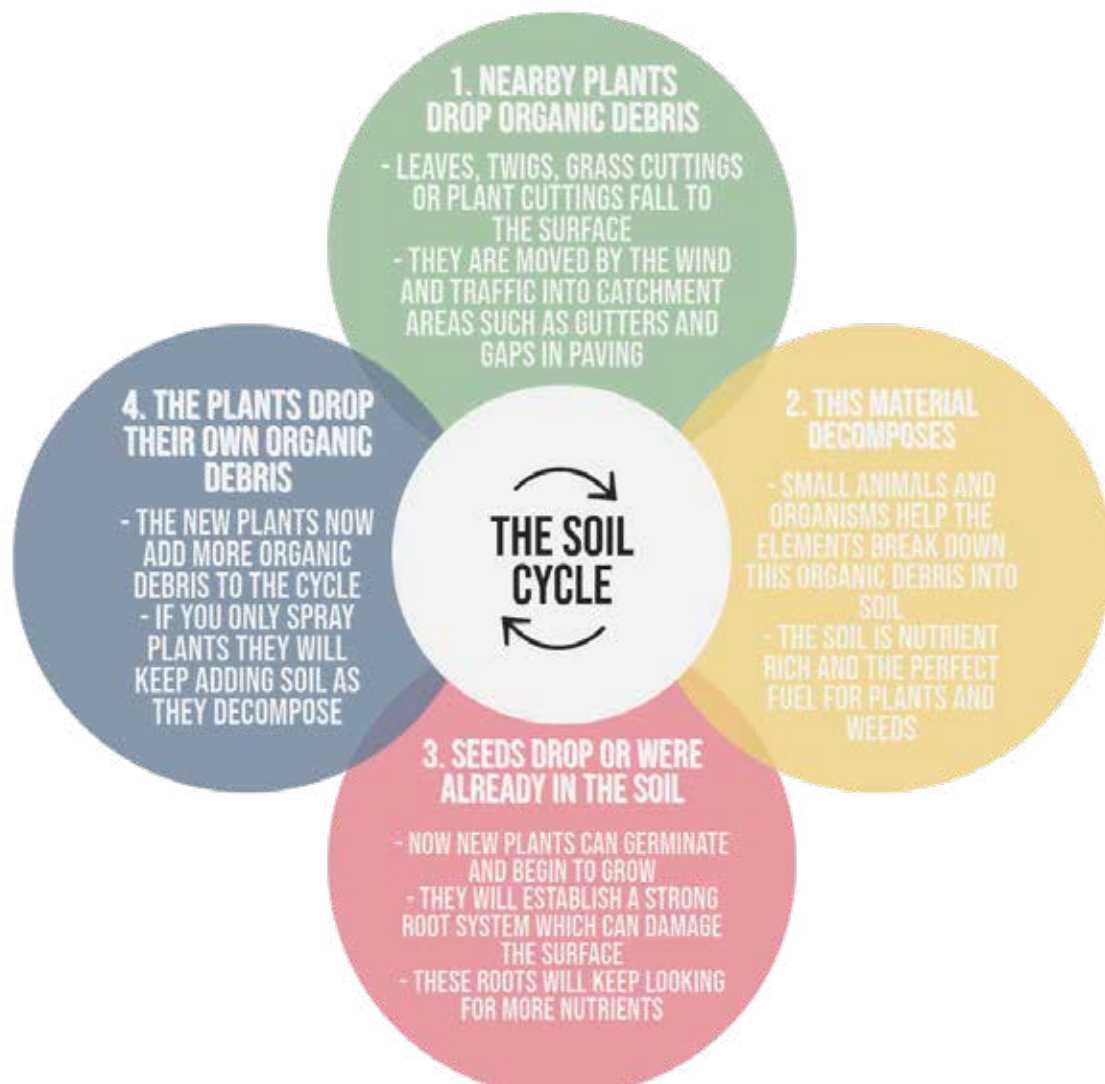



So what is Integrated Weed Management...

The law of instrument stated by Abraham Maslow suggests that „*when all you have is a hammer, every problem looks like a nail*“. Well when all you have is a chemical pesticide, it is easy to see every problem as a weed to be sprayed. However, if you have the right tools in your box then suddenly you can solve more problems. Integrated weed control is about using the right tools to treat the actual problems, eliminating our reliance on chemical pesticides. For some situations, chemicals may be the right solution. Often however, chemicals are used to treat a weed that is a symptom of a deeper issue. Usually this can be broken down into three areas - Detritus build up; Surface Compaction; and Surface Migration.

By treating these core issues we can eliminate or greatly reduce the weeds, while solving a whole host of additional problems at the same time; such as poor drainage, potholing and access. Approaching surface maintenance in this way will keep your surfaces lasting longer and result in reduced treatment frequency.

Throughout this catalogue we have included many products that are valuable in an Integrated Weed Management approach.

From Mechanical solutions such as Weed brushes and sweepers, to thermal methods such as Weed burners and Thermal lances.

If you have any queries about the efficacy of a machine in your application please get in touch and we will be happy to help with information or demonstrations of the products.

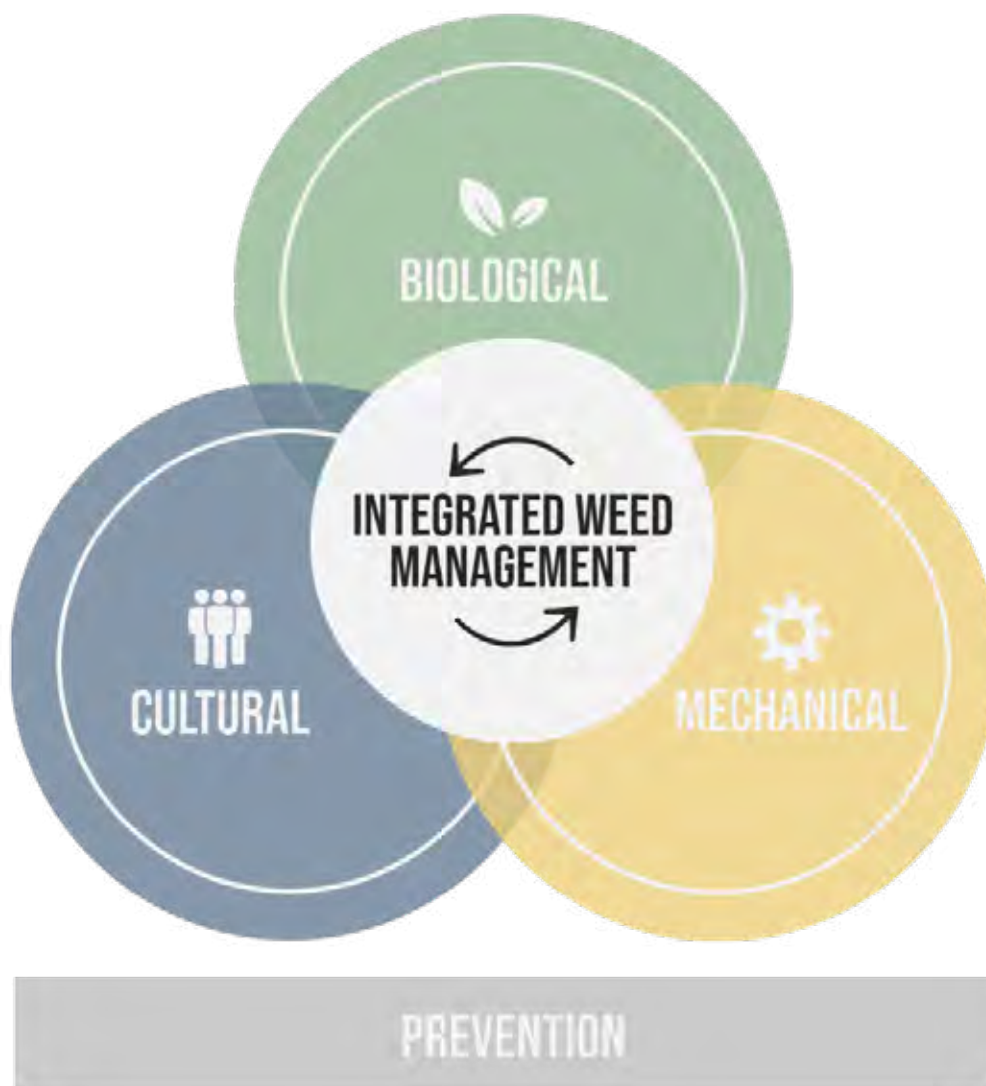

Weedo-Series Weedo II

£3995



The Weedo II features Versa Brushes, which can be replaced in just a few minutes. Brushes are available with either steel or high quality patented nylon strands.

The Weedo II is probably the toughest dedicated weedbrush available in the UK for areas such as social housing and is ideal for contractors covering many small sites. The weedbrush allows clearance of both moss and more stubborn weeds from hard surfaces such as tarmac or block paving.

Operating the machine is extremely simple, the left hand lever controls the operation of the brush, while the operator controls the forward speed by varying the pressure of the brush on the ground. The folding handlebars and its compact design mean it is easily transported from site to site and allows it to excel in tight areas. Many fine adjustments enable the brush consumption to be greatly reduced and the operator comfort to be increased. The weedbrush can be set to the right or the left hand side of the machine for clearing long paths in either direction.

Type	Dedicated Weed Brush
Max Angle	15 degrees
Engine	Honda petrol GCV160 160cc
Transmission	Hydraulic 16ltr/min Flow
Travel	Push
Axel Load	N/A
Handlebar	2 way adjustable and folding

PTO	Reversible Hydraulic drive
Attachment	50cm diameter weedbrush`
Dimensions	W 60cm - L 165cm - H 118cm
Weight	91Kg
Vibration	2.16 m/s ²
Noise	<84dB (Operator's ear)
Starting	Recoil

Part Number	Description	Price (£)
700 000 135	Steel Versa Brush (8 required per set)	9.95 each
700 000 135N	Nylon Versa Brush (8 required per set)	10.50 each



KERSTEN WEEDO II ON BLOCK PAVING

K-Series Power Units

Professional two wheel tractors with hydraulic drive; ideal for professional sweeping, preventative maintenance and light remedial tasks.

- Sweeping
- Mechanical Weed Removal
- Winter Maintenance
- Artificial Surfaces
- Light Grass Cutting



KERSTEN K1500 WITH WEEDBRUSH ATTACHMENT

Specification

K 820



Our entry level model for small sites; ideal for transporting with forward drive.

- Hydraulic Drive
- Hydraulic power take-off (PTO)
- Height Adjustable Controls

POWERED by
HONDA

K 820Pro



The comfort model for light area maintenance work with comfort functions

- Hydraulic Drive with reverse
- Variable Speed Control
- Hydraulic Power Take-off (PTO)
- Height Adjustable Controls

POWERED by
HONDA

K 1500



Our best selling power unit! Ideal for contractors.

- Hydraulic Drive with reverse
- Variable Speed Control
- Hydraulic Power Take-Off (PTO)
- Height Adjustable Dampened Controls
- Vibration Dampened Motor

POWERED by
HONDA

K 2100



Top of the range. Perfect for municipal work

- Hydraulic Drive with reverse
- Variable Speed Control
- Hydraulic Power Take-Off (PTO)
- Height Adjustable Dampened Controls
- Vibration Dampened Motor
- Optional Electric Start

POWERED by
HONDA

	Sweeper	Weedbrush	Weed burner	Snow Plough	Spreader	Knife Mower	Cylinder Mower	Wide Brush	Reciprocating Brush	Sulky Seat
K 820	✓	✓	✗	✓	✓	✓	✗	✓	✗	✓
K 820Pro	✓	✓	✓	✓	✓	✓	✗	✓	✗	✓
K 1500	✓	✓	✓	✓	✓	✓	✗	✓	✗	✓
K 2100	✓	✓	✓	✓	✓	✓	✓	✓	✓	✓

The Kersten K-series machines are designed with hydraulic drive to both the wheels and the attachments. This allows fine adjustment of wheel and implements speeds and reduces maintenance by designing out common wearing parts such as belts.

The attachments can be removed and replaced in a only few seconds by releasing the catch on the coupling system and the two quick release hydraulic hose connections. The adjustable stand allows this operation to be completed by one person.

A combination of large wheels and a free differential make handling very easy over obstacles such as kerbs. Handlebars are height adjustable at two points for maximum operator comfort in different applications. Tie down loops make securing the machine for transport very simple and the compact size of the machines make them very easy to load onto vans or trailers.

K-Series K 820 £2795

POWERED by
HONDA
160cc



Engage attachment

Engage forward drive

Throttle control

Adjustable handlebars

Fender with Reflectors

Large pneumatic tyres ideal for large obstacles such as rocks and kerbs

Quick attach K35 Connector for various attachments

The K820 is a compact power unit, ideal for handling tough jobs on smaller sites like schools and private estates. From artificial surfaces, to block paving - the attachments make it a versatile, year round maintenance tool.

This power unit is perfect for simplifying maintenance tasks such as sweeping, snow ploughing, gritting, weed clearance, and artificial surface maintenance. Attachments can be changed in a matter of seconds by disconnecting the quick release couplings and connection pin.

Operating the machine is as simple as two levers, the left hand lever controls the forward speed, while the right hand operates the hydraulic PTO connected to the attachment.

Type	Two wheel hydraulic power unit
Max Angle	15 degrees
Engine	Honda petrol GCV160 160cc
Transmission	Hydraulic with 9lt/min pump
Travel	Forwards only with diff. 0-4km/h
Axel Load	300kg
Handlebar	3 way adjustable

PTO	Hydraulic implement drive
Attachment	Kersten quick attach 35 system
Dimensions	W 60cm - L 105cm - H 115cm
Weight	90kg
Vibration	2.86 m/s ²
Noise	<84dB (Operator's ear)
Starting	Recoil



KERSTEN K820 WITH SWEEPING ATTACHMENT

K-Series K 820 Pro

£3795

POWERED by
HONDA[™]
163cc



Forwards and reverse



Engage attachment



Fender with Reflectors



Large pneumatic tyres ideal for large obstacles such as rocks and kerbs



Speed Control

Adjustable handlebars

Quick attach K35 Connector for various attachments

The K820 PRO is a compact power unit, ideal for handling tough jobs on smaller sites such as schools or sports facilities, which require more power and dexterity than a standard K820

This power unit is perfect for simplifying maintenance tasks such as sweeping, snow ploughing, gritting, weed clearance, and artificial surface maintenance. Attachments can be changed in a matter of seconds by disconnecting the quick release couplings and connection pin.

Operating the machine is as simple as two levers and a simple dashboard setup, the left hand controls the forward or reverse drive, while the right hand operates the connected attachment. Forwards or reverse can be selected on the dashboard, and the maximum speed can be set with an adjustable dial.

Type	Two wheel hydraulic power unit
Max Angle	15 degrees
Engine	Honda petrol GXV160 163cc
Transmission	Hydraulic with 12lt/min pump
Travel	Forwards/Reverse with differential. 0-6km/h
Axel Load	300kg
Handlebar	Adjustable Handles in 3 Positions

PTO	Hydraulic implement drive
Attachment	Kersten quick attach 35 system
Dimensions	W 65cm - L 105cm - H 115cm
Weight	100kg
Vibration	2.86 m/s ²
Noise	<84dB (Operator's ear)
Starting	Recoil



KERSTEN K820 PRO WITH RECIPROCATING MOWER ATTACHMENT

K-Series K 1500

£4750

POWERED by
HONDA
196cc



Forward and reverse

Variable speed control

operator presence control



Large hydraulic oil tank



Vibration Dampening

Quick attach 35 Connector for various attachments



Large pneumatic tyres ideal for large obstacles such as rocks and kerbs



The K1500 is our mid range model. It features a professional Honda GX engine, hydraulic transmission to the wheels and is ideal for a contractor with it's narrow access capabilities. The hydraulic operation also means maintenance is kept to a minimum. No belts, no clutch, no gearbox.

The versatile self-propelled machine features the Kersten Quick-Attach35 system that allows the various implements to be changed in seconds without the use of tools. The K 1500 further advances the quest for high operator comfort with low noise 82dB and vibration levels as low as 1.6m/s² can be achieved

Type	Two wheel hydraulic power unit
Max Angle	15 degrees
Engine	Honda petrol GX200 190cc
Transmission	Hydraulic with 12 L/min pump
Travel	Forwards and reverse with differential, 0-6km/h
Axel Load	300kg
Handlebar	2 way adjustable

PTO	Hydraulic implement drive
Attachment	Kersten quick attach 35 system
Dimensions	W 70cm - L 125cm - H 110cm
Weight	110kg
Vibration	1.6 m/s ²
Noise	<82dB (Operator's ear)
Starting	Recoil



KERSTEN K1500 WITH WEEDBRUSH ATTACHMENT

K-Series K 2100

£5395

POWERED by
HONDA
270cc



Forward and reverse



Large hydraulic oil tank



Transport loops



Large pneumatic tyres ideal for large obstacles such as rocks and kerbs



Variable speed control

Operator presence control

K 2100

Vibration Dampening

Quick attach K70 Connector for various attachments

The K 2100 features all the benefits of its sister machine (the K 1500) but with a lower vibration, stronger hydraulic transmission system, a more comprehensive control panel and a stronger chassis for carrying larger attachments. This machine is ideal for council work and multi site use.

Utilizing the Quick-Attach70 the K 2100 is suitable for powering not only sweeping and clearing equipment but also attachments that requiring more power, such as the cylinder mower.

Estate management teams can implement comprehensive maintenance programmes in a wide variety of applications all year round. The K2100 is low vibration, surprisingly quiet, extremely maneuverable and incredibly strong.

Type	Two wheel hydraulic power unit
Max Angle	15 degrees
Engine	Honda petrol GX270 270cc
Transmission	Hydraulic with 14lt/min pump
Travel	Forwards/Reverse with differential. 0-6km/h
Axel Load	300kg
Handlebar	2 way adjustable

PTO	Hydraulic implement drive
Attachment	Kersten quick attach 70 system
Dimensions	W 75cm - L 140cm - H 120cm
Weight	120kg
Vibration	1.6 m/s ²
Noise	<82dB (Operator's ear)
Starting	Recoil



KERSTEN K2100 WITH DE-MOSS SWEEPER

K-Series Attachments

Sweeper



Professional Sweeping attachment

- Side Driven Hydraulic Drive
- 5 Row Spiral Brush
- Height Adjustable on Two Caster Wheels
- Suitable For Snow
- Optional De-Moss Brush
- Angling Left to Right
- Pivoting to Follow Contours

- Collector Box
- Brush Guard
- Dust Suppression Kit
- Separation Collector
- Gully Brush
- De-Moss 90 Brush for K2100



Weedbrush



Professional Moss and Weed Brush attachment

- Easy to Replace Brush Segments
- Simple Pressure Adjustment
- Easily angled Left, Right, Forwards and Backwards
- Chain Drive From Hydraulic Motor
- Fixing Bolts to Maintain Angle
- Stone and Debris Guard
- 40cm Diameter Head

- Metal Versa Brushes
- Nylon Versa Brushes



Weed Burner



Professional Infrared Weed Burning attachment

- Wide 75cm Hood
- Heats to 600°C using infrared radiation
- Supported by large Casters
- Liquid Propane Gas Supply
- Electronic Ignition
- Optional Side Ejection For Kerbs
- Bottle Retention Straps



Snow Plough



Premium Snow Plough

- Sprung Trip Protection System
- Urethane Blade
- Manual Angling Left and Right
- Adjustable Skids
- Pivoting to Follow Ground Contours
- Rolled Steel Mould Board

- Snow Chains
- Weight
- Urethane Edge

Spreader



Professional Gritter/Spreader

- Suitable for a Range of Salt and Sand Applications
- Filter to Break up Clumped Material
- Supported on Heavy Duty Casters
- Conical Steel Hopper
- Specially Designed Damp Material Agitator
- Manually Adjustable Material Output
- Adjustable Baffles to Control Spread Width

- Hopper Cover

Knife Mower



Professional Reciprocating Knife Mower

- Height Adjustable Skids
- Patented Carbodux Blades
- Counter-Balancing Weights
- Anti Clogging System
- Low Vibration Knife Action

Cylinder mower



Professional Cylinder Mower

- 86cm Compact Housing
- Side Driven With Chain Drive
- Fine Screw Thread Height Adjustment
- Replaceable Skid Plates
- 6 Blade Spiral Cylinder
- Adjustable Bottom Blade

Wide Brush



2.5m Folding Brush

- Height Adjustable Casters
- Brush Folds for Access Through Single Gate
- Suitable For a Wide Range of Artificial Surfaces
- Stiff Nylon Bristles
- Garage Support Stand
- Puncture Proof Tyres

- Balance Weights

Reciprocating brush



Reciprocating Artificial Surface Brush

- Stiff Nylon Brush
- Simple Height Adjustment
- Simple Top Link Pitch Adjustment
- Transportation Support Wheel
- Suitable for a wide range of artificial surfaces
- Oscillating Brush Action

Sulky Seat



Upholstered Tow Behind Chair

- Bracket Connection to Two Wheel Tractor
- Comfortable Seat
- Ergonomic Foot Rests
- Large Solid Tyres
- Adjustable Positioning to Handlebars

EFKM-Series Sweeper



Quick release hydraulic couplings

Mounting point for collector box and gully brush

Simple height adjustmet levers



5-row nylon spiral brush

Side Driven with hydraulic motor



Specialist De-Moss Nylon brush

Kersten sweepers have been specifically designed to remove soil and heavy debris on hard surfaces. This is achieved by several very important design features that are not typically found on other sweepers.

The brush – We use 5 spiral rows of bristles on our roller brush. The gaps between the rows provide space for movement of larger volumes of heavy debris. The spiral pattern allows pressure to be applied across a narrow section of the brush rather than the full width. Less power is required to move heavy material at this point, than across the whole brush at once, so the brush can tackle much heavier material than other brushes. The Sweeper has many other advantages that greatly increase its efficacy, such as ergonomic height adjustment - especially useful for artificial surfaces and compensating for brush wear. Angling of the brush from left to right allows easy windrowing of material.

The brush can be fitted with a great range of accessories, such as the collector box, gully brush and debris guard; making it an extremely versatile machine.

Model Number	Price (£)	K820	K820 Pro	K1500	K2100
EFKM 09032 H-K 35 (90cm working width)	1400	✓	✓	✓	✗
EFKM 10037 H-KU 70 (100cm working width)	2100	✗	✗	✗	✓
EFKM 90 DE-MOSS (90cm working width)	1950	✗	✗	✗	✓

Accessories:

Part Number	Description	Price (£)
GUSPL 090	Front Brush Guard 90cm	210
GUSPL 100	Front Brush Guard 100cm	220
SSB 090K	Collector Box 90cm	550
SSB 100K	Collector Box 100cm	695
SS 090B-KR	Separator Collector 90cm	750

Part Number	Description	Price (£)
SSB 100B-KR	Separator Collector 100cm	795
ASH 403237	Hydraulic Gully Brush 40cm	995
105 425 400	Replacement Gully Brush 40cm	95
090 010 032	Replacement Brush 90cm	365
100 510 037	Replacement Brush 100cm	395
999 712 142	Replacement Brush De-Moss	365



KERSTEN K820 PRO WITH SWEEPER AND COLLECTOR

WKB-Series Weedbrush

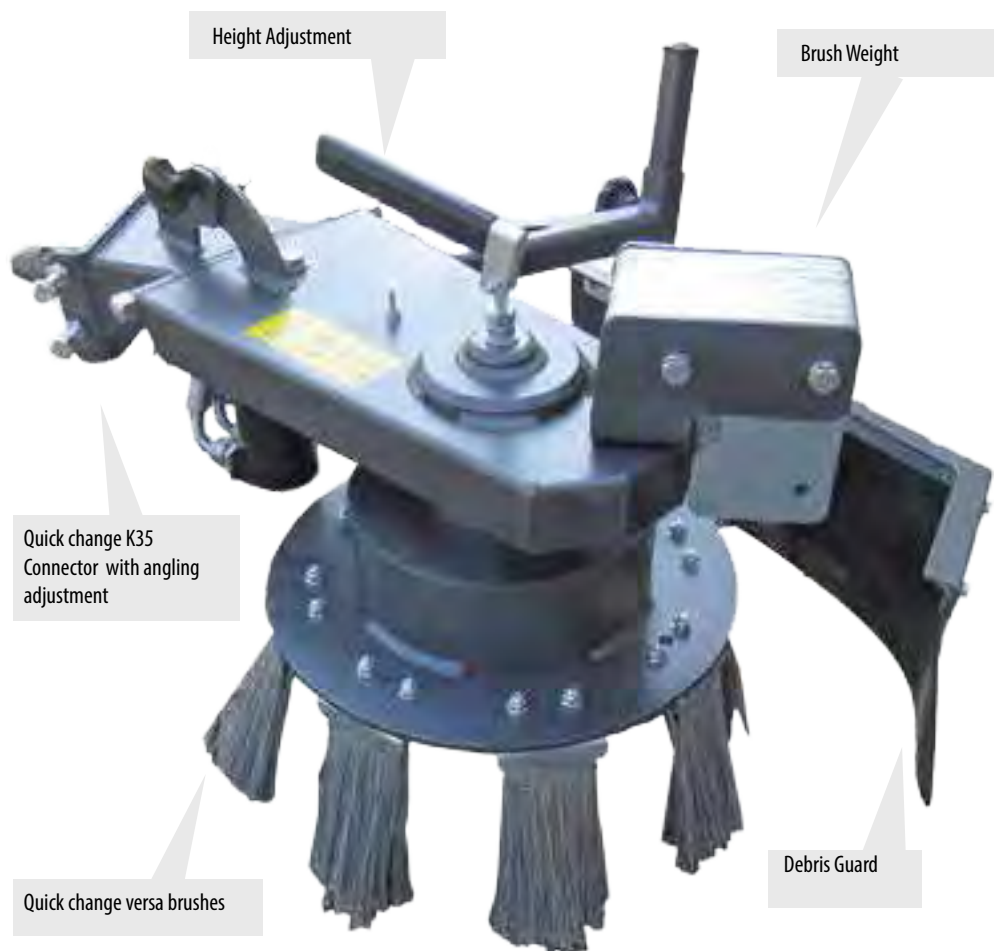

The WKB-H features Versa Brushes, which can be replaced in just a few minutes. Brushes are available with either steel or high quality patented nylon strands.

When moss and weeds become established on hard surfaces they are difficult to remove with a sweeper. For this application we have made the Weedbrush.

Kersten WeedBrushes have been designed to quickly remove weeds and moss, along with the soil they grow in from hard surfaces like tarmac and block paving. We achieve this with several features not typically found on other Weedbrushes.

VersaBrush – The WeedBrush is fitted with VersaBrushes. These brush sections are composed of two wire types. Thick flat wires are used to cut the weeds and soil from the surface and removes the material; like using many tiny shovels. Thinner wire then sweeps the surface clean. The more soil that we can remove the longer the surface will remain free of weeds.

The Weedbrush is fully adjustable with angling and pressure settings that let you get in every nook and cranny. Stone propulsion is minimised with the slow rotation speed and stone guard, also keeping material close to the brush for easy clear up.

Model Number	Price (£)	K820	K820 Pro	K1500	K2100
WKB-H-K35-820 (40cm working width)	2100	✓	✓	✗	✗
WKB-H-K35-1500 (40cm working width)	2100	✗	✗	✓	✗
WKB-H-K70-2100 (40cm working width)	2100	✗	✗	✗	✓

Part Number	Description	Price (£)
700 000 135	Steel Versa Brush (8 required per set)	9.95 each
700 000 135N	Nylon Versa Brush (8 required per set)	10.50 each



KERSTEN K1500 WITH WEEDBRUSH

ThermHit-Series Weed Burner



The Hoaf Infra Plus System uses infrared radiation in combination with hot air. By exposing the unwanted vegetation to this process, the proteins in the weeds congeal and the moisture cells burst open at about 80°C. As a result the vegetation starts wilting and dies.

The design allows great access into tight areas and paths, but the working width of the unit is large enough for covering sizeable areas in a short time. Because the product relies on heat, it can be used in the wet; allowing your weed killing to be less weather dependent. The hood design makes it easy to get right up to obstacles and the low hood allows access under park benches and picnic tables.

Model Number	Price (£)	K820	K820 Pro	K1500	K2100
TWB 75K K820Pro (75cm working width)	4995	✗	✓	✗	✗
TWB 75K K1500 (75cm working width)	4995	✗	✗	✓	✗
TWB 75K K2100 (75cm working width)	4995	✗	✗	✗	✓



KERSTEN K820 PRO WITH HOAF THERMHIT 75 ATTACHMENT

SCHN-Series Snow Plough

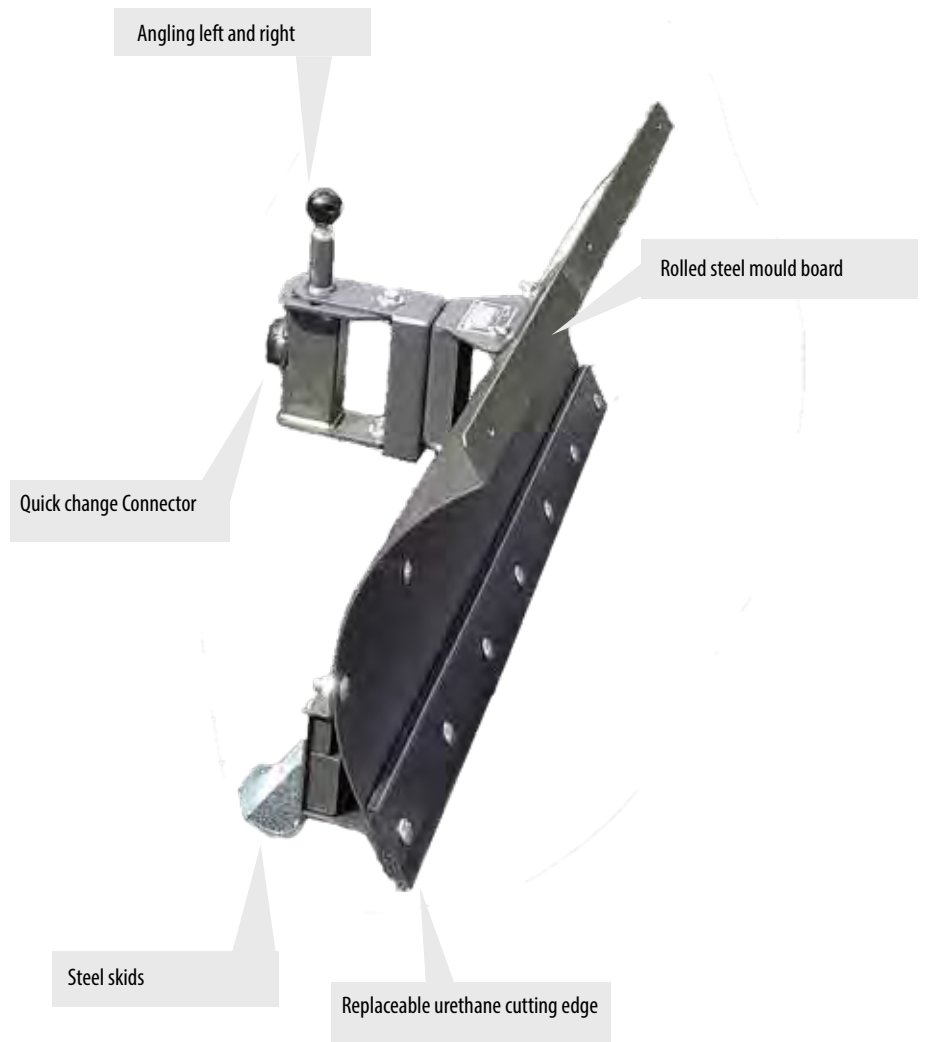

The Kersten two-wheel tractors can be fitted with snow chains and winter attachments to transform your machine into the ultimate winter companion for paths and car parks. The hydraulic drive is extremely useful for slowing the wheel speed to avoid slipping on the icy surface when using the winter attachments.

The snow plough – A snow plough attachment can be fitted to the K-series or UBS for dealing with heavier snow drifts. The snow plough is a straight blade with a sprung “break-back” system that allows it to ride over obstacles such as drain covers or speed bumps. The plough can be positioned for ploughing forward or can be angled to the left and right. You might also consider clearing light snow with the sweeper

Model Number	Price (£)	K820	K820 Pro	K1500	K2100
SCHN 100 ST-K 35 (100cm working width)	850	✓	✓	✓	✗
SCHN 100 FK-MS-KU 70 (100cm working width)	950	✗	✗	✗	✓
SCHN 125 FK-MS-KU 70 (125cm working width)	995	✗	✗	✗	✓

Part Number	Description	Price (£)
RGW 400X8	Wheel Weights 13Kg Pair	320
SCHNK 400X8	Snow Chains Pair	85
800 105 106	Urethane Edge 100cm	45
800 125 106	Urethane Edge 125cm	55



KERSTEN K820 WITH SNOW PLOUGH ATTACHMENT

SLDST-Series Gritter/Spreader



Damp material agitator



Flow control lever

Hopper Screen



70ltr Hopper

Heavy duty support casters



Adjustable support stand



The Kersten two-wheel tractors can be fitted with snow chains and winter attachments to transform your machine into the ultimate winter companion for paths and car parks. The hydraulic drive is extremely useful for slowing the wheel speed to avoid slipping on the icy surface when using the winter attachments.

The salt spreader - A hydraulic drive salt spreader is available for the K-series machines, which can carry up to 70 litres of salt. The spreader is fitted with a mesh for breaking up large clumps of salt before they go through the machine. A special agitator has been designed to deal with damp salt, using a chain to break up the material. Guards allow the spread width to be adjusted to suit the application.

Model Number	Price (£)	K820	K820 Pro	K1500	K2100
SLDST 70K 35	2395	✓	✓	✓	✗
SLDST 70H-K 70	2395	✗	✗	✗	✓

Part Number	Description	Price (£)
ADP-SLDST	Hopper Cover	120



KERSTEN POWER UNIT WITH SPREADER

DOME-Series Knife Mowers



Counter balance weights

Quick release connectors

Adjustable steel skids

Transport guard

Patented Carbodux Blades



Grass cutting is one of the most intensive jobs for maintenance teams in summer months. The Kersten machines can be utilised through the summer by fitting them with our range of specialised grass cutting equipment.

The 90cm wide reciprocating knife mowers are ideal for conservation as they provide minimal disturbance to the ecology of the grass surface. The reciprocating knives cut at the base of the plant, leaving the whole crop above this point intact. This makes it easy to rake up for baling and keeps seed heads mostly intact, which is good for propagation of wild flower meadows. Kersten have partnered with ESM to use their patented anti-clogging Carbodux blades. The attachment can be fitted with balancing weights, making it well suited to the power unit and comfortable to use. The scissor action requires less power than other methods, resulting in a universally more sustainable grass cutting system.

Model Number	Price (£)	K820	K820 Pro	K1500	K2100
DOME 090 H-K 35 (90cm working width)	1795	✓	✓	✓	✗
DOME 090 H-K 70 (90cm working width)	1950	✗	✗	✗	✓

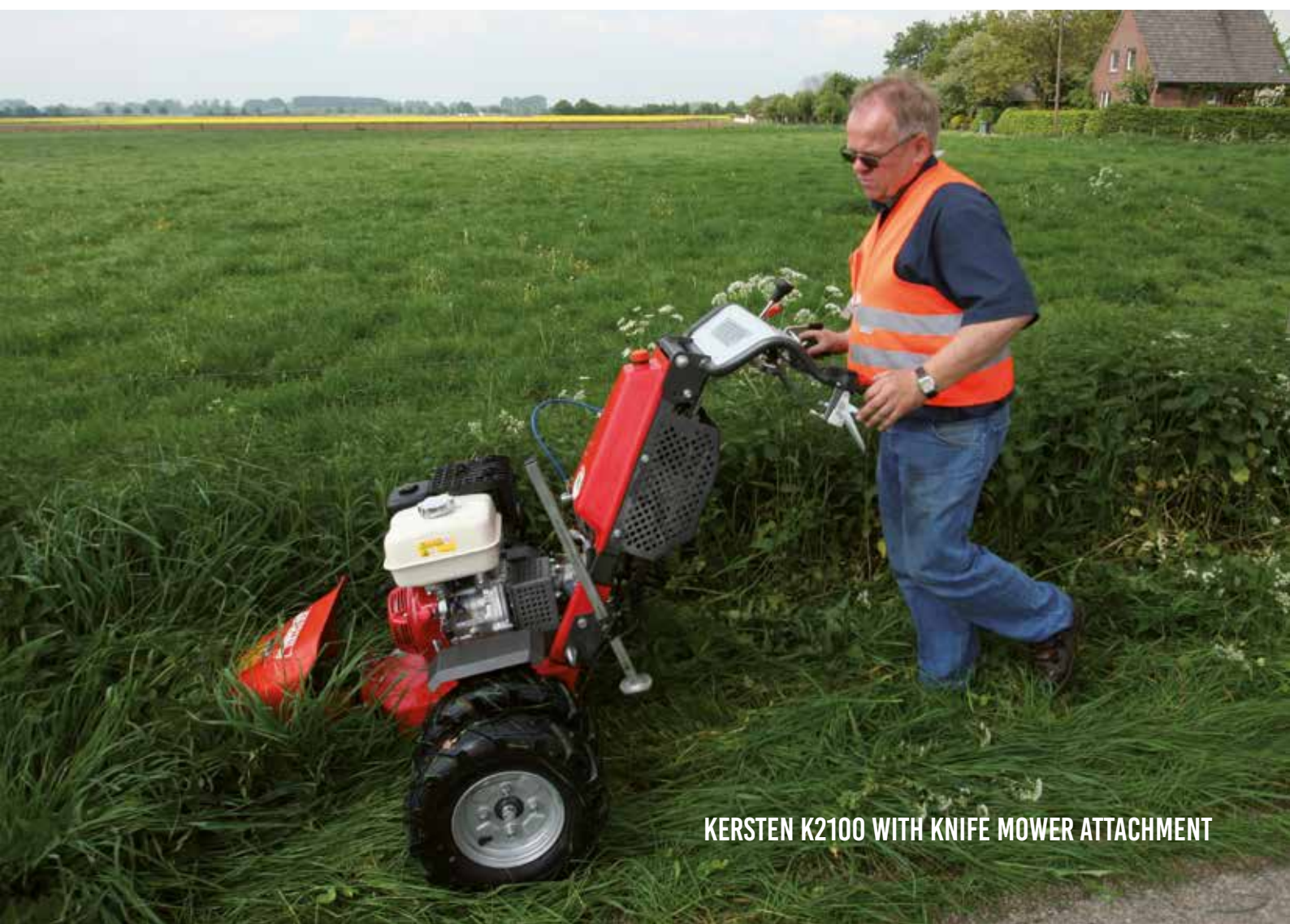

KERSTEN K2100 WITH KNIFE MOWER ATTACHMENT

CM-Series Cylinder Mower

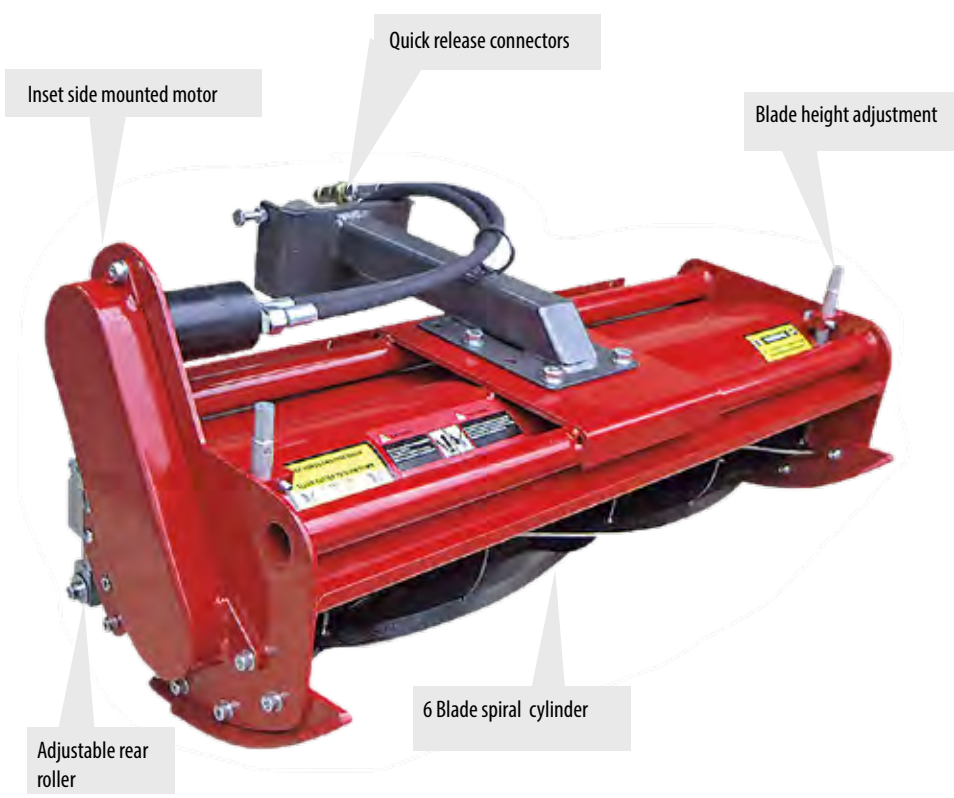

The K2100 can be fitted with a cylinder mower for commercial mowing applications. Cylinder lawn mowers give a fantastic finish; they cut the grass very cleanly compared to a rotary mower, resulting in a quicker recovery time and healthier grass.

With low vibration and low noise, our machines make the job less stressful.

The clean lines of the side plates allow the operator to mow close to obstacles to reduce secondary trimming and the compact design allows the mower to squeeze through a 36" gate for mowing in housing estates and other narrow access areas.

The full width adjustable roller allows the cutting height to be finely set between 13mm and 50mm. The high clip rate gives a quality finish at forward speeds of up to 7km/h.

Model Number	Price (£)	K820	K820 Pro	K1500	K2100
CM 976 MULTIH-K70 (86cm working width)	2895	✗	✗	✗	✓



KERSTEN K2100 WITH CYLINDER MOWER

KRB-Series Wide Area Brush



Our uniquely designed Static Brushes are ideal for regular maintenance of artificial grass surfaces. Incorporating a 2.5m set of stiff brushes, which fold up to fit through single gates. The design puts pressure across the whole brush, to effectively re-distribute the surface infill and stand up the grass pile.

During daily play, the infill of the surface will be moved around on players feet - creating troughs and mounds that make the surface uneven. The fibres in an artificial pitch give maximum support and the best performance when pointing upright and supported evenly by the sand or rubber crumb.

Model Number	Price (£)	K820	K820 Pro	K1500	K2100
KRB 250 KU 35 (250cm working width)	2350	✓	✓	✓	✗
KRB 250 KU 70 (250cm working width)	2350	✗	✗	✗	✓

Part Number	Description	Price (£)
100 510 080	Replacement Brushes (3 required per set)	99



K2100 WITH WIDE AREA BRUSH

RPB-Series Reciprocating Brush



The powered oscillating brush is equally effective on natural and synthetic turf for sports field, golf course, and amenity maintenance.

Brushing is necessary to evenly distribute top dressing and remove excess material on natural turf and on synthetic surfaces, keeping infill loose and even to prevent surface compaction. The versatile reciprocating brush can perform all of these tasks.

It uses fewer passes than a conventional drag brush, causing less compaction and due to the bi directional movement it does a more thorough job of presenting the pile on artificial surfaces.

Model Number	Price (£)	K820	K820 Pro	K1500	K2100
RPB 100 (100cm working width)	2995	✗	✗	✗	✓

Part Number	Description	Price (£)
100 510 080	Replacement Brushes (2 required per set)	99



KERSTEN POWER UNIT WITH RECIPROCATING BRUSH

SULK-Series Sulky Seat



Kersten provides a sulky for convenient operation of the K-series two wheel tractors. This can be useful in open areas with even surfaces, such as football pitches and tennis courts. The upholstered chair is covered with plastic - and therefore insensitive to dirt and water. The sitting position can be adjusted in different ways using the drawbar and the seat attachment

The steps can also be adjusted to suit the operator. This means that the handlebar and the control panel is within easy reach. There are footrests on the drawbar, which contribute to an ergonomic sitting position.

Uncoupling the sulky seat just takes one pin.

Model Number	Price (£)	K820	K820 Pro	K1500	K2100
SULK-SWH	995	✓	✓	✓	✓



KERSTEN K820PRO WITH SULKY SEAT





UBS-Series

Professional two wheel tractors with mechanical PTO; ideal for professional users carrying out heavy remedial and preventitive maintenance tasks

- Sweeping
- Mechanical Weed Removal
- Winter Maintenance
- Artificial Surfaces
- Commercial Mowing
- Foliage Removal



KERSTEN UBS HYDRO II WITH FLAIL MOWER ATTACHMENT

Model	Specification	Sweeper	Weedbrush	Weed burner	Snow Plough	Spreader	Snow Blower	Knife Mower	Rotary Mower	Flail Mower TSM	Flail Mower SCHLM	Drum Mower	Gravel Path Renovator	Power Harrow	Seeder	Wide Brush	Blower
 <h3>Hydro 9</h3> <p>Entry level model for the commercial sector</p> <ul style="list-style-type: none"> Suitable for slopes up to 20 degrees Hydrostatic Drive Height adjustable control console Hydraulic Power Take-Off (PTO) Device Quick Connector Dead Man's Handle <p>POWERED by HONDA™</p>	<ul style="list-style-type: none"> ✓ ✓ ✓ ✓ ✓ ✗ ✓ ✓ ✓ ✗ ✗ ✗ ✗ ✗ ✓ ✓ 																
 <h3>Hydro II</h3> <p>Universal professional model for continuous use</p> <ul style="list-style-type: none"> Suitable for slopes up to 20 degrees Optimal vibration dampening Height adjustable control console Hydraulic Power Take-Off (PTO) Device Quick Connector E-Start (Optional) <p>BRIGGS & STRATTON</p>	<ul style="list-style-type: none"> ✓ ✓ ✓ ✓ ✓ ✓ ✓ ✓ ✓ ✓ ✓ ✓ ✓ ✓ ✓ ✓ 																
 <h3>Master II</h3> <p>Robust and powerful for bigger jobs on larger sites</p> <ul style="list-style-type: none"> Suitable for slopes up to 30 degrees Axial piston pump Individual wheel motors Vibration dampened, height adjustable controls Hydraulic Power Take-Off (PTO) Duplex V-Belt Operating hours counter <p>BRIGGS & STRATTON</p>	<ul style="list-style-type: none"> ✗ ✗ ✗ ✗ ✗ ✓ ✓ ✓ ✓ ✓ ✓ ✓ ✓ ✓ ✓ ✗ ✗ 																
 <h3>Alpin 23</h3> <p>Premium model for the biggest, toughest jobs</p> <ul style="list-style-type: none"> Suitable for slopes up to 45 degrees Hydro pro steering Swivelling, vibration dampening, control console Vibration dampened, height adjustable controls Hydraulic Power Take-Off (PTO) Duplex V-Belt Operating hours counter <p>BRIGGS & STRATTON</p>	<ul style="list-style-type: none"> ✗ ✗ ✗ ✗ ✗ ✓ ✓ ✗ ✓ ✓ ✓ ✗ ✓ ✓ ✓ ✗ ✗ 																

For heavy duty applications that require more power we have the UBS series, which are shown in the following pages.

These machines all have hydraulic drive to the wheels, but they have a direct mechanical drive to the attachments. This delivers power to implements as efficiently as possible. This mechanical drive is necessary for power hungry tasks such as path edging, flail mowing and snow throwing. In the UBS series; the chassis is also enhanced to give extra support for coping with the additional strain these jobs put on the machine.

Some of these tasks require the machine to work on a slope or with heavy attachments. For this reason the UBS Hydro machines are fitted with independent heavy duty wheel motors to make the machine easy to steer.

For severe slopes the Hydro II, Master and Alpin series are fitted with handlebars that can be adjusted to the left and right as well as for height. This allows the operator to maintain a more stable position on a steep gradient while controlling the machine.

UBS-Series Hydro 9

£7995

POWERED by
HONDA

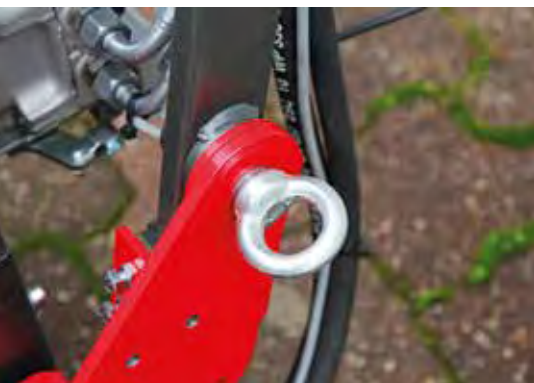

The UBS Hydro 9 Kersten Two Wheel Tractor is an incredibly versatile, machine with mechanical PTO and much more power. Ideal for lengthy, heavier tasks in grass cutting, weed removal, path edging and artificial surfaces. For Contractors and Councils in parks and city center.

The machine features hydraulic drive to the wheels, with steering using wheel motors and unlike the K-Series it has a direct mechanical drive to the attachments. This delivers power to implements as efficiently as possible. This mechanical drive is necessary for power hungry tasks such as path edging and mowing. In the UBS series the chassis is also enhanced to give extra support for coping with the additional strain these jobs put on the machine.

The Kersten Quick-Attach70 system allows the wide range of implements to be changed in seconds. An adjustable stand allows you to do this with only one operator

Type	Two wheel hydraulic power unit
Max Angle	20 degrees
Engine	Honda petrol GX270 270cc
Transmission	Hydraulic Transmission 12ltr/min
Travel	Forwards/Reverse with diff. 0-6km/h
Axel Load	300kg
Handlebar	3 way adjustable

PTO	Mechanical implement drive 1200 - 3000 RPM
Attachment	Kersten quick attach 70M system
Dimensions	W 77cm - L 129cm - H 119cm
Weight	169kg
Vibration	2.7 m/s ²
Noise	<82dB (Operator's ear)
Starting	Recoil



KERSTEN HYDRO II 13 WITH WEEDBRUSH ATTACHMENT

UBS-Series Hydro II 13

£9395

POWERED by
HONDA



Variable speed control



Forward and reverse



Independent wheel steering



Quick change K70M Connector for various attachments



Dead man's handle



Large hydraulic oil tank

Vibration Dampening

Large pneumatic tyres ideal for large obstacles such as rocks and kerbs

The UBS Hydro II 13 Kersten Two Wheel Tractor takes comfort and power to a new level with our largest professional Honda Engine. Perfectly suited for lengthy, heavier tasks in grass cutting, weed removal, path edging and artificial surfaces. For Contractors and Councils in parks and city centre.

The machine features hydraulic drive to the wheels, with steering using wheel motors and like the UBS 9 it has a direct mechanical drive to the attachments. The additional power of this unit makes it capable of carrying out heavier tasks and the Z-flex handlebars provide maximum comfort and control for the operator. The Kersten Quick-Attach70 system allows the wide range of implements to be changed in seconds. An adjustable stand allows you to do this with only one operator. The Hydro II range have our lowest vibration ratings, so you can use the machine all day long.

Type	Two wheel hydraulic power unit
Max Angle	20 degrees
Engine	Honda petrol GX390 390cc
Transmission	Hydraulic Transmission 12ltr/min
Travel	Forwards/Reverse with diff. 0-6km/h
Axel Load	300kg
Handlebar	Adjustable Z flex handlebars

PTO	Mechanical implement drive 1350 - 3400 Rpm
Attachment	Kersten quick attach 70M system
Dimensions	W 75cm - L 142cm - H 127cm
Weight	171kg
Vibration	1.5 m/s ²
Noise	<82dB (Operator's ear)
Starting	Recoil



KERSTEN HYDRO II 13 WITH ROTARY MOWER

UBS-Series Hydro II 16

£10500



Variable speed control

Dead man's handle

Large hydraulic oil tank

Forward and reverse

Independent wheel steering

Vibration Dampening

Quick change K70M Connector for various attachments

Large pneumatic tyres ideal for large obstacles such as rocks and kerbs

The UBS Hydro II 16 is an incredibly versatile machine with mechanical PTO and much more power from its twin cylinder Briggs & Stratton Vanguard engine. It will power through heavy path edging, flail mowing and gravel path renovation that smaller models aren't able to manage so easily.

Thanks to the heavy duty wheel motors and power steering, these machines can operate on banks, and the low vibrations from the Z-flex handlebars allow you to use the machine all day long.

The Kersten Quick-Attach70 system makes it easy for the wide range of implements to be changed in seconds.

Type	Two wheel hydraulic power unit
Max Angle	20 degrees
Engine	Briggs & Stratton Vanguard 16hp twin cylinder 469cc
Transmission	Hydraulic Transmission 18ltr/min
Travel	Forwards/Reverse with diff. 0-6km/h
Axel Load	600kg
Handlebar	Adjustable Z flex handlebars

PTO	Mechanical implement drive 1350 - 3400 Rpm
Attachment	Kersten quick attach 70M system
Dimensions	W 75cm - L 142cm - H 127cm
Weight	171kg
Vibration	1.5 m/s ²
Noise	<84dB (Operator's ear)
Starting	Electric



KERSTEN HYDRO II 16 WITH WEEDBRUSH ATTACHMENT

UBS-Series Master II

£12195



Variable speed control

Dead man's handle

Large hydraulic oil tank

Forward and reverse

Independent wheel steering

Vibration Dampening

Quick change K70M Connector for various attachments

Large pneumatic tyres ideal for large obstacles such as rocks and kerbs

Fingertip control and versatility in one powerful package, for professional heavy duty flail mowing, and winter maintenance, allowing you to work on slopes up to 30 degrees all day long! Ideal for doing bank work and power hungry tasks.

The 18hp Twin cylinder Vanguard engine, is our mid range model from the Hydro range. It is able to handle our most power hungry attachments.

The Incline control valve – holds the machine on slopes up to a 30° angle with minimal operator effort. The easily adjustable control panel makes it simple to use and combined with the Comfort Control system is one of the most manageable machines on the market for bank work.

Type	Two wheel hydraulic power unit
Max Angle	30 degrees
Engine	Briggs & Stratton Vanguard 18hp twin cylinder 570cc
Transmission	Hydraulic Transmission 18ltr/min
Travel	Forwards/Reverse with diff. 0-6km/h
Axel Load	3600kg
Handlebar	Adjustable Z flex handlebars

PTO	Mechanical implement drive 1350 - 3400 Rpm
Attachment	Kersten quick attach 70M system
Dimensions	W 110cm - L 142cm - H 127cm
Weight	265kg
Vibration	1.5 m/s ²
Noise	<84dB (Operator's ear)
Starting	Electric



KERSTEN MASTER II WITH FLAIL MOWER ATTACHMENT

UBS-Series Alpin 23

£15950



Variable speed control

Forward and reverse

Large hydraulic oil tank

Independent wheel steering

Vibration Dampening

Quick change K70M Connector for various attachments

Large pneumatic tyres ideal for large obstacles such as rocks and kerbs

Heavy duty wheel motors for 45° banks

The largest machine in our range. Fingertip control and versatility in our most powerful package, for professional heavy duty flail mowing, and working up to 45 degrees all day long! Ideal for doing bank work and power hungry tasks.

The 23hp Twin cylinder Vanguard engine, paired with the robust Hydraulic transmission make this our most capable Multi-attachment machine. The Incline control valve – holds the machine on slopes up to a 45° angle without complaint. The easily adjustable control panel makes it simple to use and combined with the Comfort Control system is one of the most manageable machines on the market for bank work.

Type	Two wheel hydraulic power unit
Max Angle	45 degrees
Engine	Briggs & Stratton Vanguard 23hp twin cylinder 570cc
Transmission	Hydraulic Transmission 21ltr/min
Travel	Forwards/Reverse with diff. 0-6km/h
Axel Load	3600kg
Handlebar	Adjustable Z flex handlebars

PTO	Mechanical implement drive 1350 - 3400 Rpm
Attachment	Kersten quick attach 70M system
Dimensions	W 110cm - L 160cm - H 127cm
Weight	295kg
Vibration	1.5 m/s ²
Noise	<84dB (Operator's ear)
Starting	Electric



KERSTEN ALPIN 23 WITH FLAIL MOWER ATTACHMENT

UBS-Series Comfort Drive



Forward and reverse

Speed setting with nine increments

Work mode

Transport mode

The new “Comfort Drive” control system has some incredible features that make the machine really simple to operate. The comfort drive system has 9 speed settings which can be selected by sliding your thumb over the potentiometer. The speeds can be split into two ranges, with a working range and transport range, which are interchangeable at the touch of a button. When the transport range is selected a green light will show on the control. The machine can be put in forwards or reverse gear by pressing another button on the console. When changing between forwards and reverse, the machine will do this in two stages for extremely smooth operation. The comfort drive makes the machine virtually effortless to use and is extremely helpful for sites where lots of speed changes and manoeuvring are required, such as on slopes or in tight spaces. The comfort drive can only be fitted to machines with electric start as it needs an external battery supply. The sophisticated control box senses the electrical directions from the controls and automatically adjusts the hydraulic system via a linear motor to perform the required operations.

Model Number	Price (£)	UBS Hydro 9	UBS Hydro 13	UBS Hydro 16	UBS Master	UBS Alpin
comfort-drive	1350	✗	✓	✓	✓	✓



KERSTEN HYDRO II FITTED WITH COMFORT DRIVE

UBS Attachments

Sweeper



Professional Sweeping attachment

- Side Driven Mechanical Drive
- 5 Row Spiral Brush
- Height Adjustable on Two Caster Wheels
- Suitable For Snow
- Angling Left to Right
- Pivoting to Follow Contours

- Collector Box
- Brush Guard
- Dust Suppression Kit
- Separation Collector
- Gully Brush Left/Right



Weedbrush



Professional Moss and Weed Brush attachment

- Easy to Replace Brush Segments
- Simple Pressure Adjustment
- Easily angled Left, Right, Forwards and Backwards
- PTO Drive to Gear Box
- Fixing Bolts to Maintain Angle
- Stone and Debris Guard
- 60cm Diameter Head

- Metal Versa Brushes
- Nylon Versa Brushes
- Hausa Brushes



Weed Burner



Professional Infrared Weed Burning attachment

- Wide 100cm Hood
- Heats to 600°C using infrared radiation
- Supported by large Casters
- Liquid Propane Gas Supply
- Electronic Ignition
- Optional Side Ejection For Kerbs
- Bottle Retention Straps

- Snow Chains
- Weight
- Urethane Edge



Snow Plough



Premium Snow Plough

- Sprung Trip Protection System
- Urethane Blade
- Manual Angling Left and Right
- Adjustable Skids
- Pivoting to Follow Ground Contours
- Rolled Steel Mould Board

Spreader



Professional Gritter/Spreader

- Suitable for a Range of Salt and Sand Applications
- Filter to Break up Clumped Material
- Supported on Heavy Duty Casters
- Conical Steel Hopper
- Specially Designed Damp Material Agitator
- Manually Adjustable Material Output
- Adjustable Baffles to Control Spread Width

- Hopper Cover

Snow Blower



Professional Two Stage Snow Blower

- 180° Rotational Chute
- Large Diameter Aggressive Cutting Teeth
- 80cm Working Width
- Up to 8m Snow Propulsion
- Protective Guard Rail
- Heavy Duty Skids
- Direct PTO Drive

Knife Mower



Professional Reciprocating Knife Mower

- Height Adjustable Skids
- Patented Carbodux Blades
- Counter-Balancing Weights
- Anti Clogging System
- Low Vibration Knife Action

Rotary Mower



Professional Side Discharge Mower

- Oil Bath Bevel Gear Drive
- Twin Rotor Swing Tip Blades
- Heavy Duty Castor Wheels
- High Airflow from Blade Lift
- Side Discharge
- Strong Steel Casing
- Pivoting to Follow Ground Contours
- Sprung Deck Tensioning

Flail Mower



Lightweight Flail Mower

- Y Type Flail Blades
- Up to 3cm Diameter Material
- Simple Height Adjustment
- Protective Guard Rails
- Protective Debris Guards
- Heavy Duty Castors
- Balanced Spiral Rotor

Flail Mower



Heavy Duty Flail Mower

- Y or Boot Type Flail Blades
- Up to 5cm Diameter Material
- Simple Height Adjustment
- Protective Guard Rails
- Protective Debris Chains
- Heavy Duty Castors
- Balanced Spiral Rotor

UBS Attachments

Drum Mower



Professional Rotary Drum Mower

- Protective Debris Guard
- Steel Guard Rails
- Two Contra Rotating Drums
- Swing Tip Blades
- Oil Bath Gear Box
- Pivoting Attachment to Follow Contours

Gravel Path Renovator



Heavy Duty Gravel Path Renovator

- 90cm Working Width
- Oil Bath Gear Box
- Finely Adjustable Working Depth
- Heavy Duty Support Wheels
- Rear Roller
- Pivoting Connection to Follow Contours
- Screw Thread Pitch Adjustment
- Steel Guard Rail

- Knife Blades
- Weed Brushes
- Bullet Tines

Power Harrow



Professional Power Harrow

- 90cm Working Width
- Oil Bath Gear Box
- Finely Adjustable Working Depth
- Front Roller
- Sprung Steel Baffles
- Connection for Seeding Attachment

Seeder



Professional Seeding Attachment

- Connects to Power Harrow
- Wheel Drive From Roller
- Adjustable Seed Distribution
- Large Seed Hopper
- All Steel Construction

Wide Brush



2.5m Folding Brush

- Height Adjustable Casters
- Brush Folds for Access Through Single Gate
- Suitable For a Wide Range of Artificial Surfaces
- Stiff Nylon Bristles
- Garage Support Stand
- Puncture Proof Tyres

- Balance Weights

Blower



Low Noise Leaf Blower

- Less Than 84dB
- Adjustable Nozzle
- Dynamically Balanced Fan
- Durable Plastic Housing
- Heavy Duty Castor Wheel
- Up to 12m Distribution



EFKM-Series Sweeper



Kersten sweepers have been specifically designed to remove soil and heavy debris on hard surfaces. This is achieved by several very important design features that are not typically found on other sweepers.

The brush – We use 5 spiral rows of bristles on our roller brush. The gaps between the rows provide space for movement of larger volumes of heavy debris. The spiral pattern allows pressure to be applied across a narrow section of the brush rather than the full width. Less power is required to move heavy material at this point, than across the whole brush at once, so the brush can tackle much heavier material than other brushes. The Sweeper has many other advantages that greatly increase its efficacy, such as ergonomic height adjustment - especially useful for artificial surfaces and compensating for brush wear. Angling of the brush from left to right allows easy windrowing of material.

The brush can be fitted with a great range of accessories, such as the collector box, gully brush and debris guard; making it an extremely versatile machine.

Model Number	Price (£)	UBS Hydro 9	UBS Hydro 13	UBS Hydro 16	UBS Master	UBS Alpin
EFKM 10037 M-MU 70 (100cm working width)	2350	✓	✓	✓	✗	✗
EFKM 12537 M-MU 70 (125cm working width)	2395	✓	✓	✓	✗	✗

Accessoires:

Part Number	Description	Price (£)
GUSPL 100	Front Brush Guard 100cm	220
GUSPL 125	Front Brush Guard 125cm	250
SSB 100K	Collector Box 100cm	695
SSB 125K	Collector Box 125cm	750
SS 100B-KR	Separator Collector 100cm	750

Part Number	Description	Price (£)
SSB 125B-KR	Separator Collector 125cm	865
WAS 51K 1500	Dust Suppression Kit 5Ltr	595
ASM 403237	Belt Gully Brush 40cm	695
105 425 400	Replacement Gully Brush 40cm	95
100 510 037	Replacement Brush 100cm	395
125 010 037	Replacement Brush 125cm	425



KERSTEN UBS HYDRO 13 WITH SWEEPING ATTACHMENT AND COLLETOR BOX

WKB-Series Weedbrush

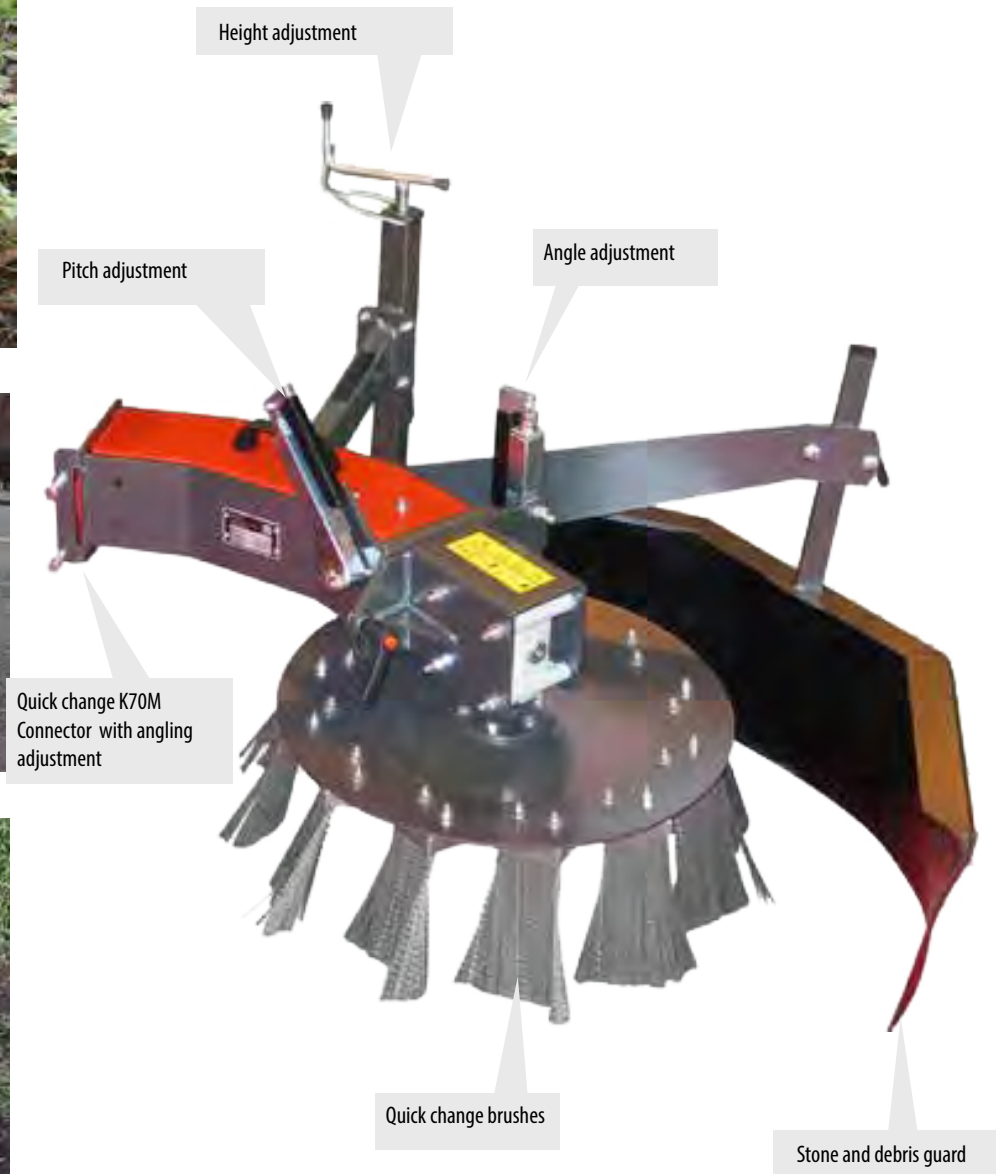

When moss and weeds become established on hard surfaces they are difficult to remove with a sweeper. For this application we have the Weedbrush. Kersten WeedBrushes have been designed to quickly remove weeds and moss, along with the soil they grow in from hard surfaces like tarmac and block paving. We achieve this with several features not typically found on other Weedbrushes. VersaBrush – The WeedBrush is fitted with VersaBrushes. These brush sections are composed of two wire types. Thick flat wires are used to cut the weeds and soil from the surface and removes the material; like using many tiny shovels. Thinner wire then sweeps the surface clean. The more soil that we can remove the longer the surface will remain free of weeds. The Weedbrush is fully adjustable with angling and pressure settings that let you get in every nook and cranny. Stone propulsion is minimised with the slow rotation speed and stone guard, also keeping material close to the brush for easy clear up

Model Number	Price (£)	UBS Hydro 9	UBS Hydro 13	UBS Hydro 16	UBS Master	UBS Alpin
WKB 60 M-U 70 (60cm working width)	2695	✓	✓	✓	✗	✗

Part Number	Description	Price (£)
BLGW-WKB 60	Front Weight	250
700 000 135	Steel Versa Brush (10 Required per set)	9.95
700 000 135N	Nylon Versa Brush (10 Required per set)	10.95
700 000136A	Hausa Brush set with Bracket (10 Required per set. Only one set required)	19.95
106 780 200	Hausa Brush Sections (10 Required per set)	9.95



UBS HYDRO 16 WITH WEEDBRUSH ATTACHMENT

ThermHit-Series Weed Burner



The Hoaf Infra Plus System uses infrared radiation in combination with hot air. By exposing the unwanted vegetation to this process, the proteins in the weeds congeal and the moisture cells burst open at about 80°C. As a result the vegetation starts wilting and dies.

The design allows great access into tight areas and paths, but the working width of the unit is large enough for covering sizeable areas in a short time. Because the product relies on heat, it can be used in the wet; allowing your weed killing to be less weather dependent. The hood design makes it easy to get right up to obstacles and the low hood allows access under park benches and picnic tables.

Model Number	Price (£)	UBS Hydro 9	UBS Hydro 13	UBS Hydro 16	UBS Master	UBS Alpin
TWB 75K (75cm working width)	2695	✓	✓	✓	✗	✗



KERSTEN POWER UNIT WITH THERMHIT WEED BURNER

SCHN-Series Snow Plough

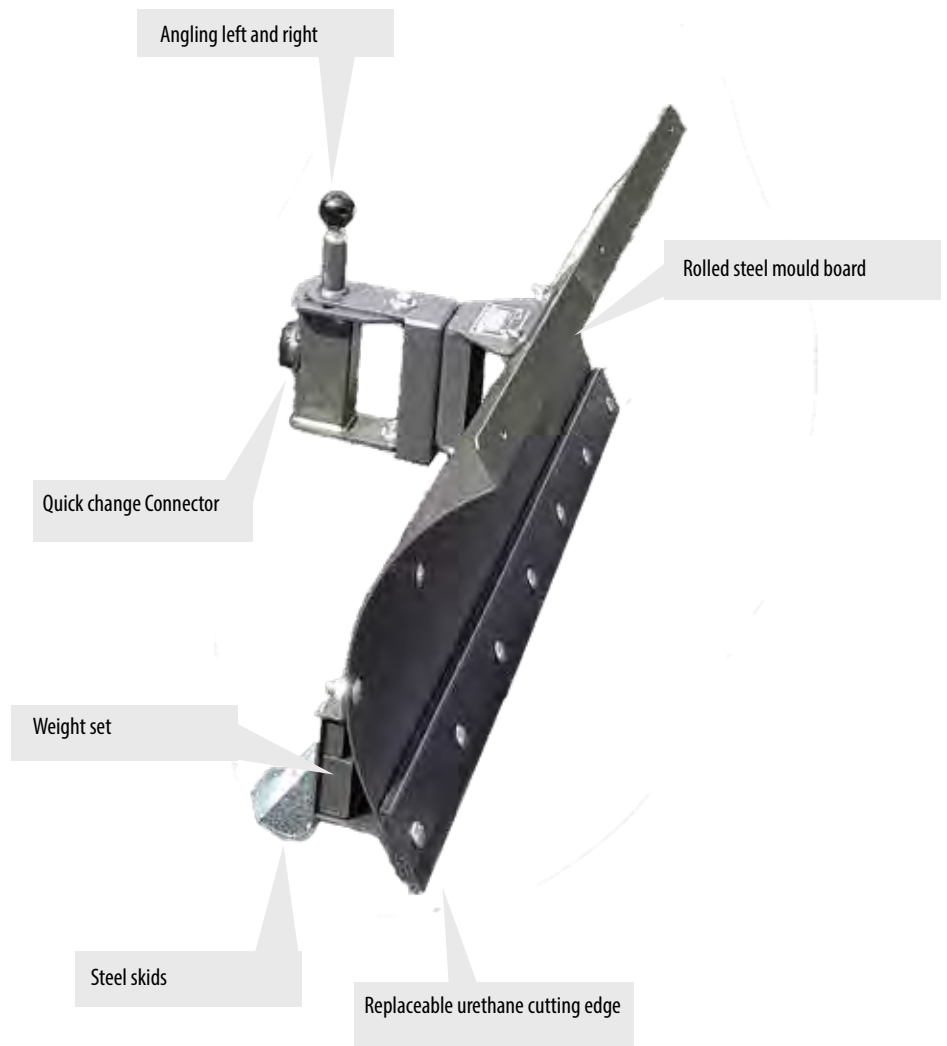

The Kersten two-wheel tractors can be fitted with snow chains and winter attachments to transform your machine into the ultimate winter companion for paths and car parks. The hydraulic drive is extremely useful for slowing the wheel speed to avoid slipping on the icy surface when using the winter attachments.

The snow plough – A snow plough attachment can be fitted to the K-series or UBS for dealing with heavier snow drifts. The snow plough is a straight blade with a sprung “break-back” system that allows it to ride over obstacles such as drain covers or speed bumps. The plough can be positioned for ploughing forward or can be angled to the left and right.

Model Number	Price (£)	UBS Hydro 9	UBS Hydro 13	UBS Hydro 16	UBS Master	UBS Alpin
SCHN 100 FK-M-KU 70 (100cm working width)	950	✓	✓	✓	✗	✗
SCHN 125 FK-M-KU 70 (125cm working width)	950	✓	✓	✓	✗	✗

Part Number	Description	Price (£)
RGW 400X8	Wheel Weights 13Kg Pair	320
SCHNK 400X8	Snow Chains Pair	85
800 105 106	Urethane Cutting Edge 1M	45
800 124 106	Urethane Cutting Edge 1.25m	55



KERSTEN POWER UNIT WITH SNOW PLOUGH ATTACHMENT

SLDST-Series Gritter/Spreader



Flow control lever

Hopper Screen

70ltr Hopper

Heavy duty support casters

Adjustable support stand

Damp material agitator

The Kersten two-wheel tractors can be fitted with snow chains and winter attachments to transform your machine into the ultimate winter companion for paths and car parks. The hydraulic drive is extremely useful for slowing the wheel speed to avoid slipping on the icy surface when using the winter attachments.

The salt spreader - A PTO drive salt spreader is available for the UBS-series machines, which can carry up to 70 litres of salt. The spreader is fitted with a mesh for breaking up large clumps of salt before they go through the machine. A special agitator has been designed to deal with damp salt, using a chain to break up the material. Guards allow the spread width to be adjusted to suit the application.

Model Number	Price (£)	UBS Hydro 9	UBS Hydro 13	UBS Hydro 16	UBS Master	UBS Alpin
SLDST 70 M-U 70	2595	✓	✓	✓	✗	✗

Part Number	Description	Price (£)
ADP-SLDST	Hopper Cover	120



KERSTEN POWER UNIT WITH SPREADER ATTACHMENT

SCHNFR-Series Snow Blower

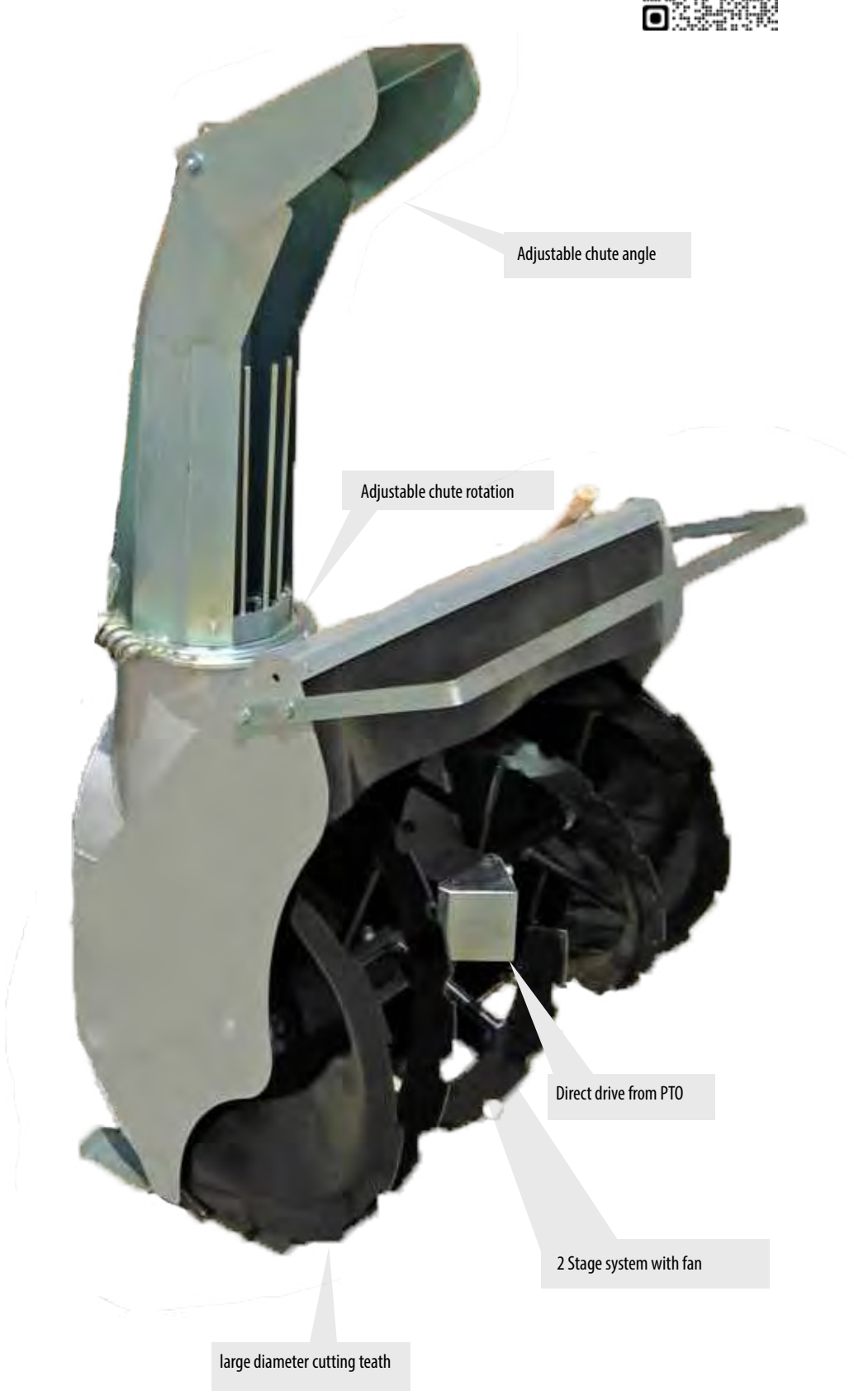

Adjustable chute angle

Adjustable chute rotation

Direct drive from PTO

2 Stage system with fan

large diameter cutting teeth

The SCHNFR series snow blower is the ultimate tool for clearing big drifts of snow. The two stage blower uses aggressive rotary teeth in the first stage, to break up snow and ice, then a fan in the second stage to propel the snow through the chute.

The chute can be angled by 180 degrees to position the snow where you want it and the machine is capable of throwing the snow up to 8 meters from the machine.

The attachment can be paired with most of our UBS series, which can be fitted with snow chains and wheel weights for additional traction, making it extremely easy to operate.

Model Number	Price (£)	UBS Hydro 9	UBS Hydro 13	UBS Hydro 16	UBS Master	UBS Alpin
SCHNFR80 (80cm working width)	3395	✗	✓	✓	✓	✓



UBS HYDRO 13 WITH SNOW BLOWER ATTACHMENT

DOME-Series Knife Mower



Grass cutting is one of the most intensive jobs for maintenance teams in summer months. The Kersten machines can be utilised through the summer by fitting them with our range of specialised grass cutting equipment.

Reciprocating knife mower – The reciprocating knife mowers are ideal for conservation as they provide minimal disturbance to the ecology of the grass surface. The reciprocating knives cut at the base of the plant, leaving the whole crop above this point intact. This makes it easy to rake up for baling and keeps seed heads mostly intact, which is good for propagation of wild flower meadows.

Model Number	Price (£)	UBS Hydro 9	UBS Hydro 13	UBS Hydro 16	UBS Master	UBS Alpin
DOME 140 M-U 70 (140cm working width)	950	✗	✓	✓	✗	✗
DOME 170 M-U 70 (170cm working width)	950	✗	✓	✓	✓	✓



ZRA-Series Rotary Mower

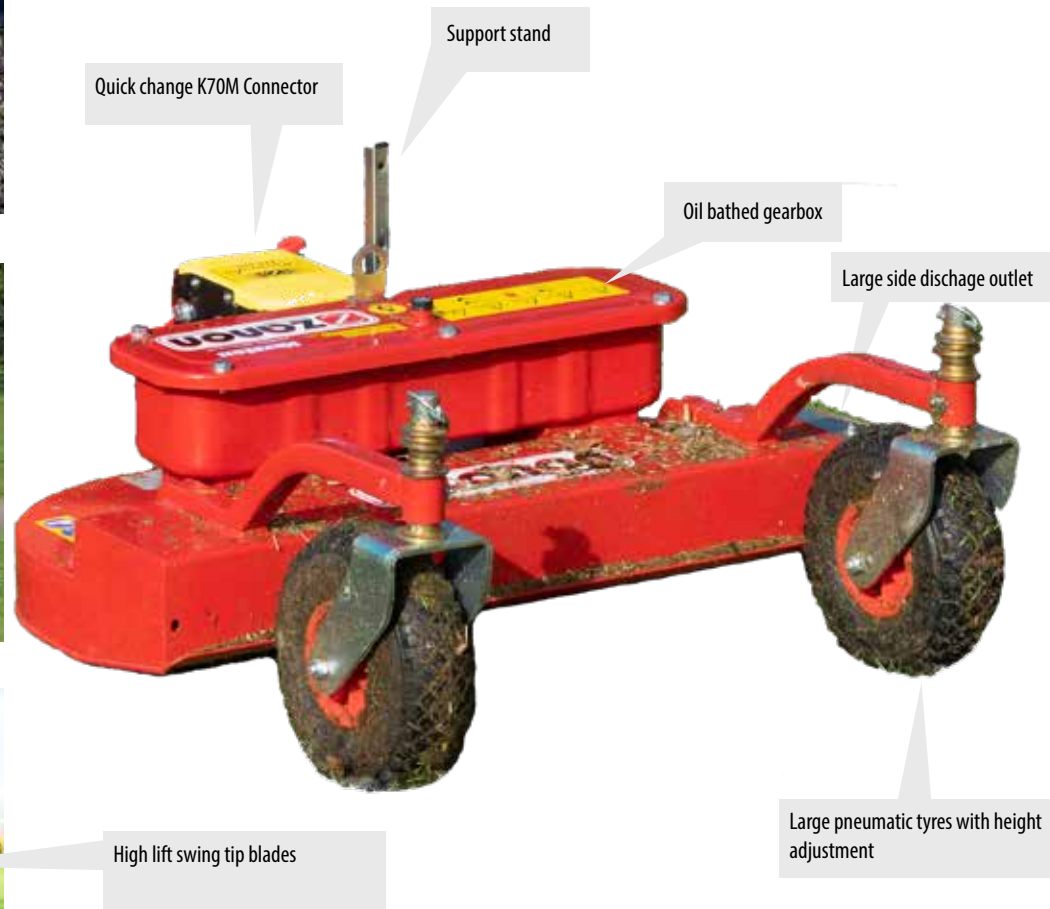

The ZRA is a professional mower for the care and maintenance of lawns in parks and gardens. The ZRA has a double height adjustment system that ensures a perfect, uniform cut. It features an oil bath gearbox with freewheel and safety key for efficient operation - greatly reducing down time from common wearing items like belts. The ZRA is fitted with swing tip blades that will protect the mower if logs or other impediments are struck during mowing.

The high lift provides a massive air flow under the deck, which throws the grass a big distance allowing even dispersal of clippings.

Model Number	Price (£)	UBS Hydro 9	UBS Hydro 13	UBS Hydro 16	UBS Master	UBS Alpin
ZRA 800 (80cm working width)	1795	✓	✓	✗	✗	✗
ZRA 1000 (100cm working width)	1895	✗	✓	✓	✓	✗

Part Number	Description	Price (£)
5.350.010	Right Hand Blade (ZRA 800)	19.50
5.350.011	Left Hand Blade (ZRA 800)	19.50
5.350.014	Right Hand Blade (ZRA 1000)	19.50
5.350.013	Left Hand Blade (ZRA 1000)	19.50



KERSTEN UBS HYDRO II 13 WITH ROTARY MOWER

TSM-Series Flail Mower



The Zanon TSM flail Mower is the ultimate companion for lighter duty, fast and efficient flail mowing. The Y-type steel knives, set in a spiral pattern achieve a great finish on grass and are capable of handling material up to 3cm in diameter.

The pivoting attachment point allows the flail to follow the contours of the ground easily and three width choices to pick from make it suitable for either narrow access areas or wide area mowing.

Robust pneumatic tyres provide height adjustment and great support for the flail in difficult terrain.

Model Number	Price (£)	UBS Hydro 9	UBS Hydro 13	UBS Hydro 16	UBS Master	UBS Alpin
TSM 600 (60cm working width)	1795	✓	✗	✗	✗	✗
TSM 900 (90cm working width)	1895	✗	✓	✓	✓	✗
TSM 1100 (110cm working width)	1995	✗	✗	✓	✓	✓

Part Number	Description	Price (£)
3.350.012	Replacement Blades (Set of 18 for TSM 600. Set of 28 for TSM 900. Set of 34 for TSM 1100)	6.95



KERSTEN UBS HYDRO II 16 WITH FLAIL MOWER ATTACHMENT

SCHLM-Series Flail Mower



Side driven with twin V belts

Top link height adjustment

Protective rails

Stone and debris guard

Dynamically balanced rotor with Y type flails and rear roller

Large pneumatic tyres with height adjustment

This is the Kersten flail deck. It's heavy duty design allows it to achieve a great finish through dense material up to 5cm in diameter. With a dynamically balanced motor, which greatly reduces the noise and vibration. This flail is extremely capable and comfortable to use.

The Flail comes with a choice of Y type blades for grass or boot type knives for denser vegetation.

The volume around the knives allows the machine to mulch the material very finely, leaving a great finish, even in long, lush grass.

Height can be adjusted on the front wheels or the optional rear roller.

Model Number	Price (£)	UBS Hydro 9	UBS Hydro 13	UBS Hydro 16	UBS Master	UBS Alpin
SCHLM 65 M-U 70 (65cm working width)	3895	✗	✓	✓	✗	✗
SCHLM 90 M-U 70 (90cm working width)	4595	✗	✗	✓	✓	✗
SCHLM 100 M-U 70 (100cm working width)	4895	✗	✗	✓	✓	✓
SCHLM 120 M-U 70 (120cm working width)	5100	✗	✗	✗	✓	✓



UBS ALPIN WITH FLAIL MOWER ATTACHMENT

KRM-Series Drum Mower



Twin drums

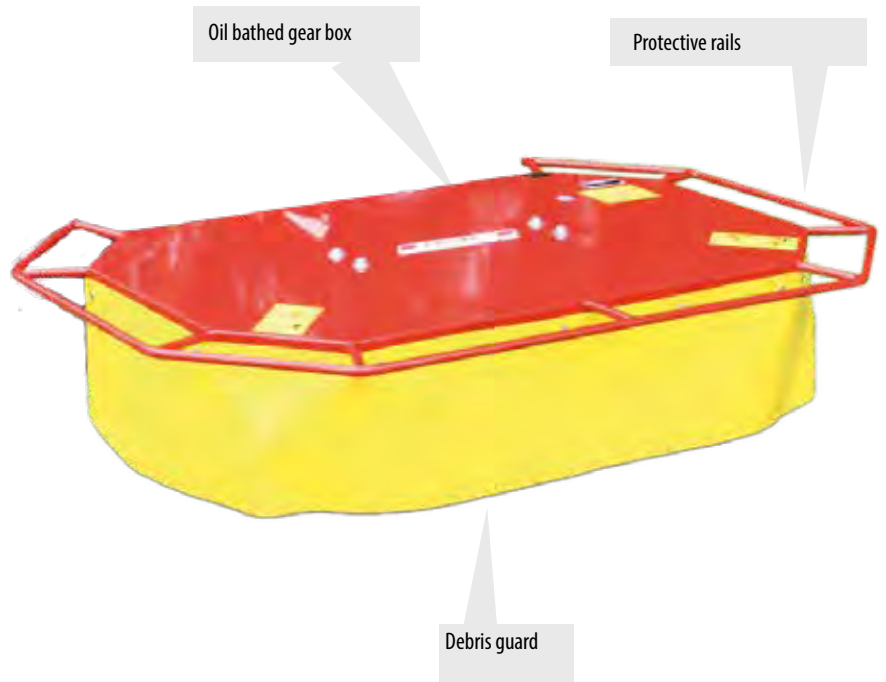

Oil bathed gear box

Protective rails

Debris guard

The Kersten drum mower is a great choice for conservation areas and mowing where the whole crop is to be left intact. A drum mower is a far quicker machine than the reciprocating knife mower, so is more suited to larger areas of grass. The drum mower provides more disturbance to the ecology than a knife mower, but still cuts the grass at the base, leaving the whole crop above this point intact for baling.

The Fabric guard provides protection from sticks and other debris kicked up by the machine, while being flexible enough not to damage the crop. Guard rails protect the mower from knocks on fencing and hedge rows, while an oil bathed gear box reduces wear on the machine and provides great power to the rotors.

Model Number	Price (£)	UBS Hydro 9	UBS Hydro 13	UBS Hydro 16	UBS Master	UBS Alpin
KRM 102 M-U 70 (102cm working width)	3295	✗	✗	✓	✓	✗
KRM 115 M-U 70 (115cm working width)	3695	✗	✗	✓	✓	✓



KERSTEN UBS WITH DRUM MOWER ATTACHMENT

WE-Series Gravel Path Renovator



Gravel is a tricky surface to maintain. But in order to keep it looking attractive, weeds must be removed regularly and good drainage should be encouraged by de-compacting the stones and bringing them back to the surface. This will ensure the longevity of the surface as well as the safety of users. Doing even small areas by hand can be pretty challenging, let alone a large area.

The Kersten Gravel Path Renovator is ideal for the task - it can de-compact the stones as well as remove the weeds by the root. Even perennial weeds will be taken out in one pass.

It works with a set of specially designed cutting knives, which cut under the root and lift the plant to the surface. At the same time, it lifts the stones back to the surface, allowing proper drainage and surface structure.

Model Number	Price (£)	UBS Hydro 9	UBS Hydro 13	UBS Hydro 16	UBS Master	UBS Alpin
WE 090 M-U 70 (90cm working width)	4995	✗	✓	✓	✓	✗

Part Number	Description	Price (£)
BLGW-WE	Front Weight	320
WM-SATZ090	Angled Knives Set (included in WE 090 M-U 70)	350
BUES-SATZ090	Brush Set	395
MEISSEL-SATZ090	Bullet Tines Set	695



KERSTEN UBS HYDRO II 16 WITH GRAVEL PATH RENOVATOR

KE-Series Power Harrow

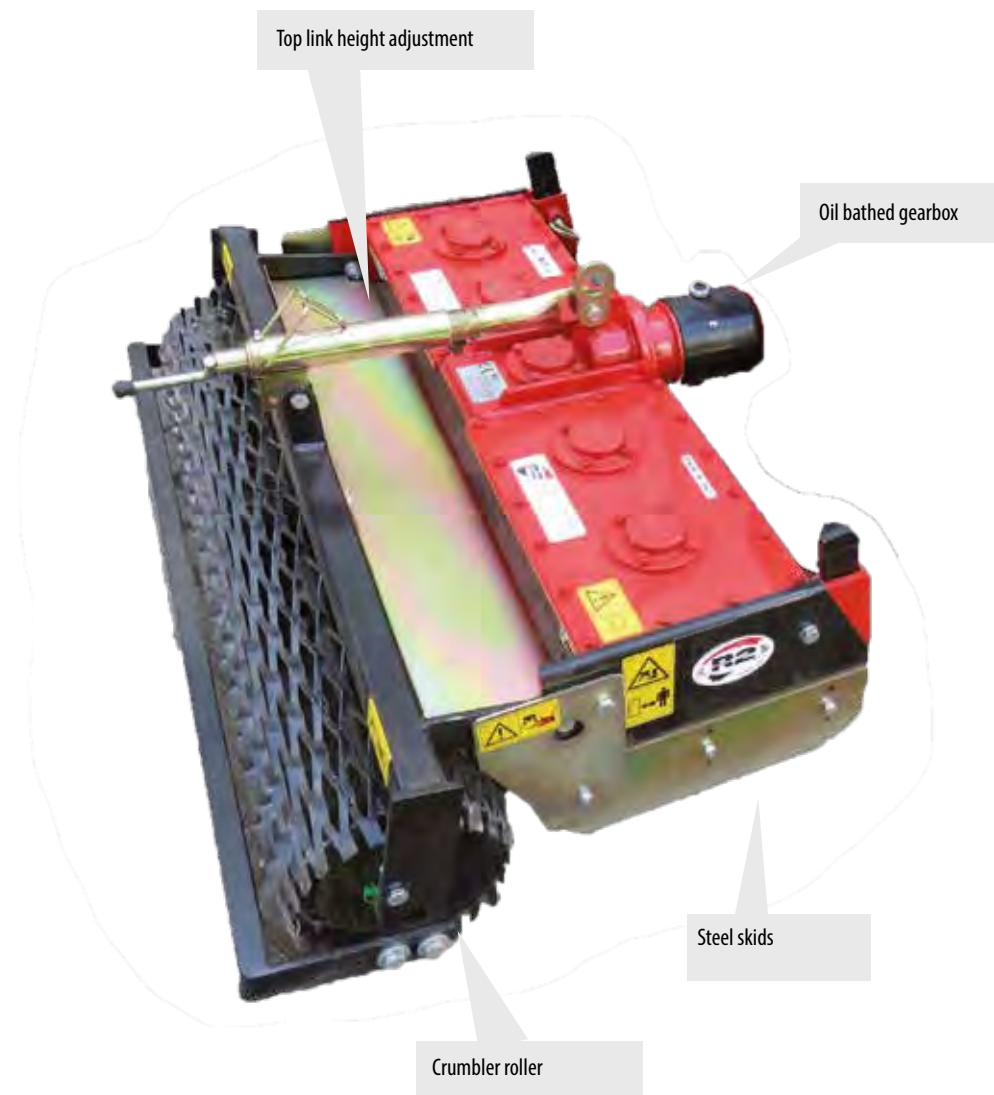

The power harrow attachment allows the soil to be prepared for seeding. The depth of action can be finely adjusted to achieve soil preparation to the correct depth. The power harrow leaves a fine, consistent soil ready for seeding.

The seeding attachment (see over page) Can be used in conjunction with the power harrow, allowing both jobs to be achieved simultaneously. This greatly enhances your productivity over other systems.

The UBS is easy to use in reverse, with the power harrow attached, to leave a great finish, free of undulations and footprints.

Model Number	Price (£)	UBS Hydro 9	UBS Hydro 13	UBS Hydro 16	UBS Master	UBS Alpin
KE 090 M-U 70 (90cm working width)	3895	✗	✓	✓	✓	✓

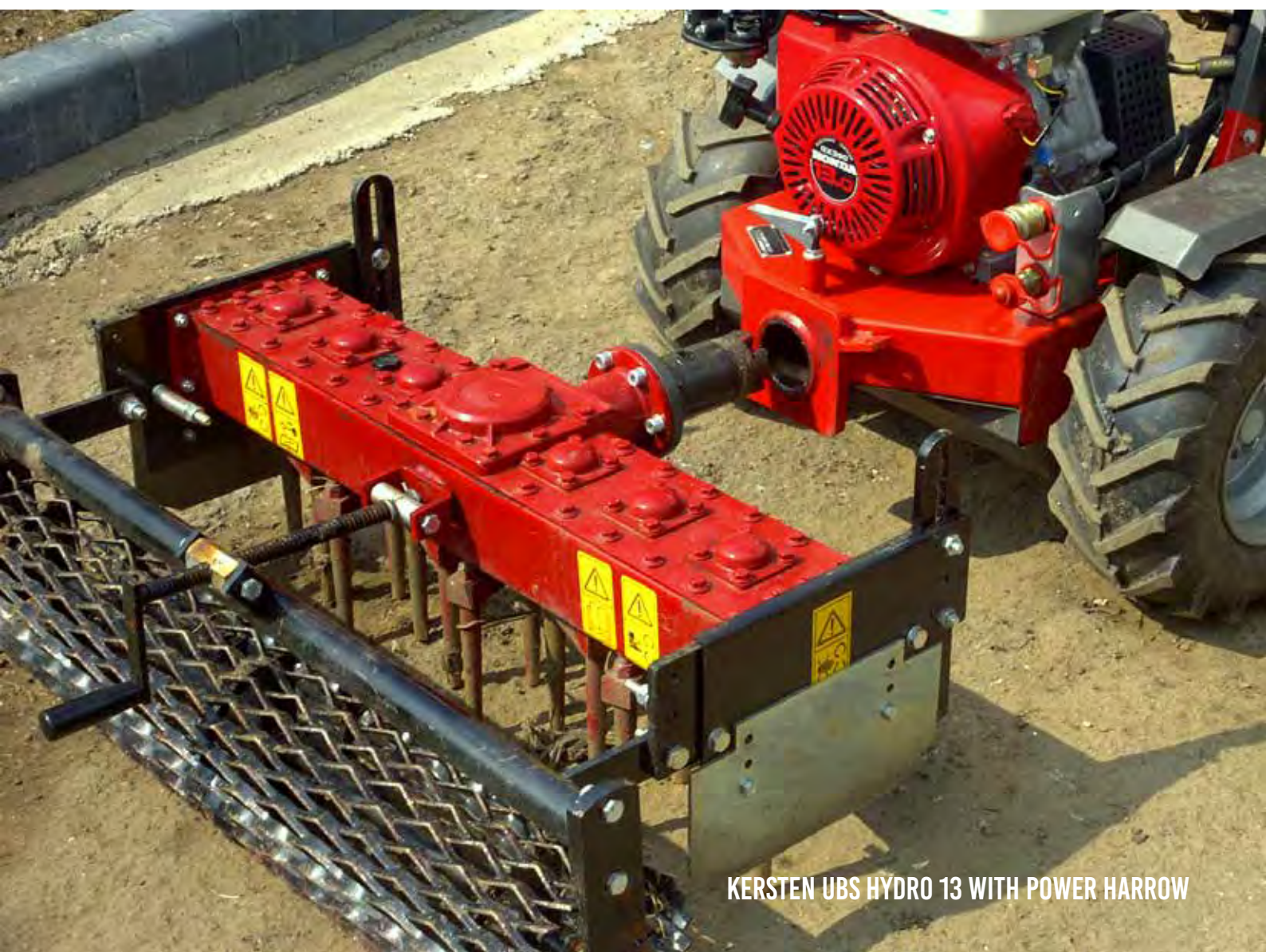

KERSTEN UBS HYDRO 13 WITH POWER HARROW

ASS-Series Seeder

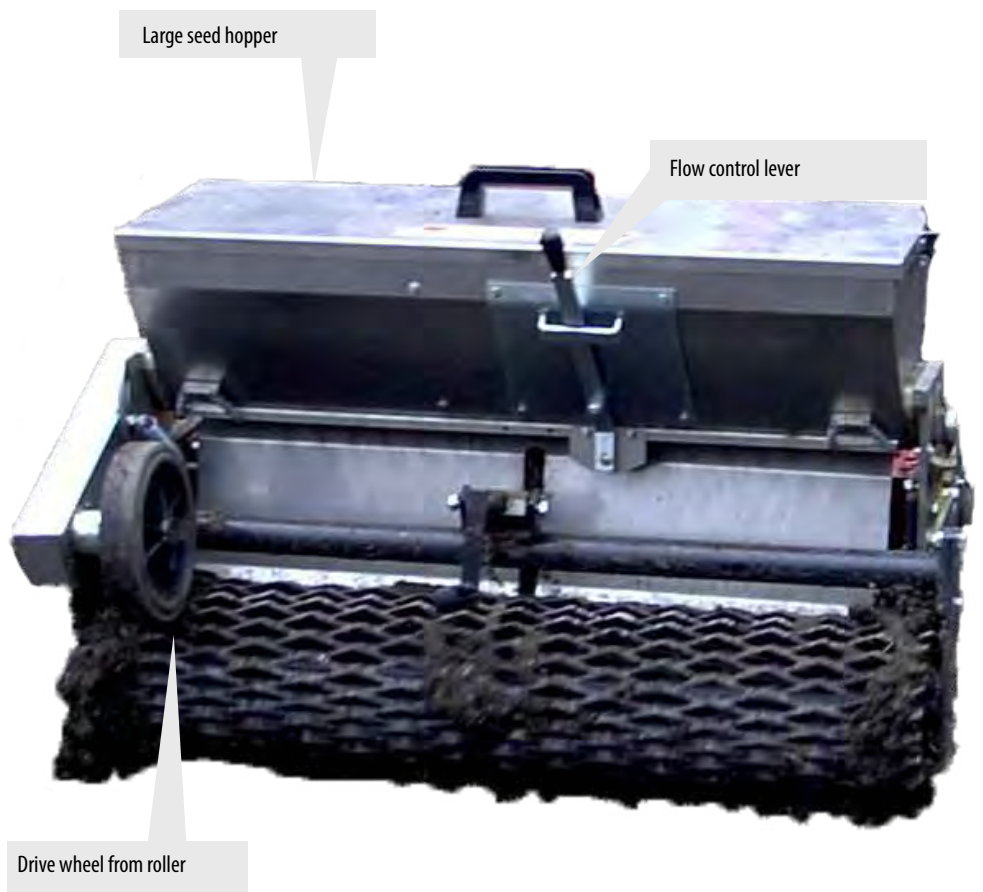

The Seeder works in conjunction with our power harrow attachment, allowing you to simultaneously cultivate and plant.

The seeds can be easily loaded into the generous hopper and dropped behind the harrow onto the freshly prepared soil. The rate of seeding can be finely adjusted using the setting lever.

the speed is set by a guide wheel that connects with the roller, adjusting the output of the seeder in accordance to the speed of the machine. This allows for a precise and even dispersal of seeds.

Model Number	Price (£)	UBS Hydro 9	UBS Hydro 13	UBS Hydro 16	UBS Master	UBS Alpin
ASS 850	2600	✗	✓	✓	✓	✓



KERSTEN UBS HYDRO II 16 WITH POWER HARROW AND SEEDER

KRB-Series Wide Area Brush



Our uniquely designed Static Brushes are ideal for regular maintenance of artificial grass surfaces. Incorporating a 2.5m set of stiff brushes, which fold up to fit through single gates. The design puts pressure across the whole brush, to effectively re-distribute the surface infill and stand up the grass pile.

During daily play, the infill of the surface will be moved around on players feet - creating troughs and mounds that make the surface uneven. The fibres in an artificial pitch give maximum support and the best performance when pointing upright and supported evenly by the sand or rubber crumb.

Model Number	Price (£)	UBS Hydro 9	UBS Hydro 13	UBS Hydro 16	UBS Master	UBS Alpin
KRB 250 M-U 70 (250cm working width)	2350	✓	✓	✓	✗	✗

Part Number	Description	Price (£)
100 510 080	Replacement Brushes (3 required per set)	99



KERSTEN K2100 WITH WIDE AREA BRUSH

LBV-Series Leaf Blower



Dynamically balanced aluminium fan

Light weight noise reducing plastic housing

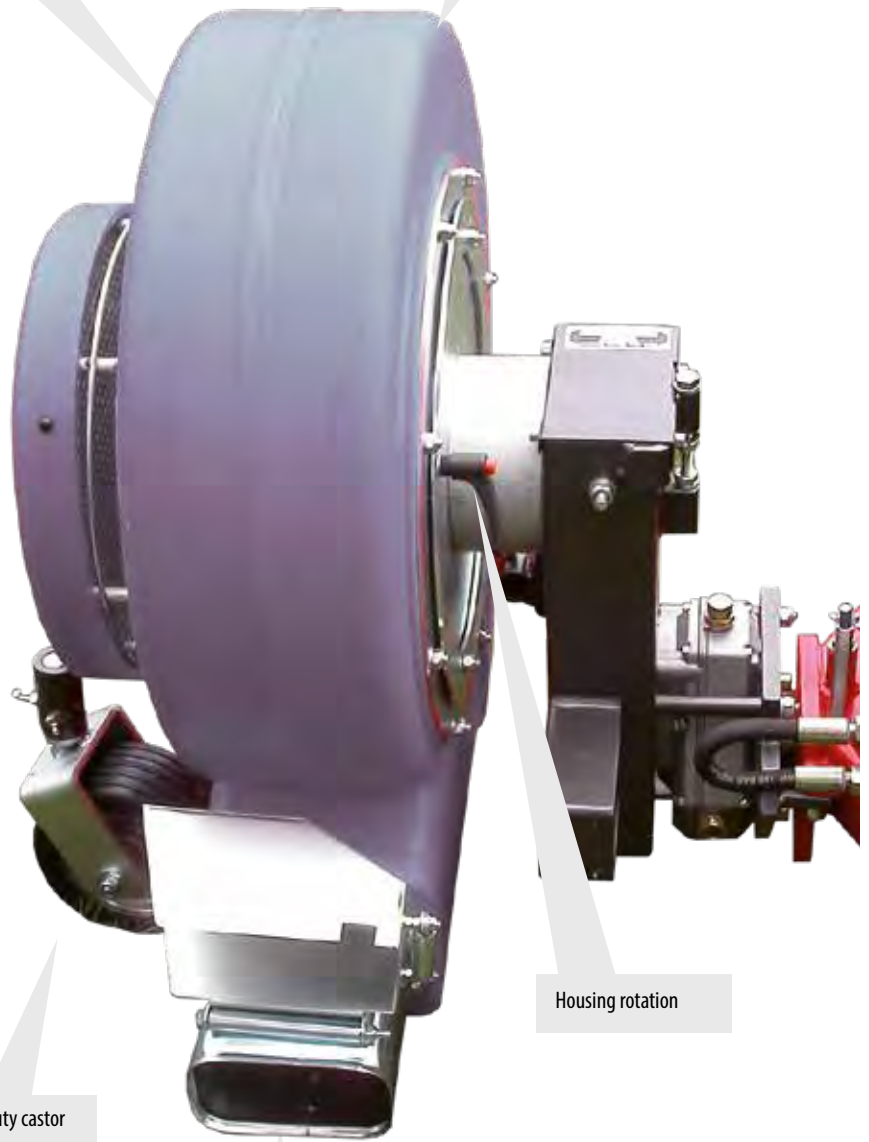

Housing rotation

Large heavy duty castor wheels

Adjustable bi-directional nozzle

The LBV series leaf blowers are now even more powerful, with either 85m³/min or 115m³/min airflow. Projecting leaves up to 8 and 12 meters respectively.

The LBV use a heavy duty plastic housing and dynamically balanced fan to keep the noise to an absolute minimum <84dB, allowing the blowers to be used without issues in Schools and public spaces.

The blower can be adjusted to clear leaves and other debris on either side of the machine, using a simple lever to adjust the nozzle direction.

The Blower is supported by a heavy duty castor that maintains the height of the output and is easy to move over rougher ground.

Model Number	Price (£)	UBS Hydro 9	UBS Hydro 13	UBS Hydro 16	UBS Master	UBS Alpin
LBV 5100 M-ABF	3195	✓	✓	✓	✗	✗
LBV 6900 M-ABF	3495	✓	✓	✓	✗	✗



KERSTEN UBS HYDRO II WITH LBV LEAF BLOWER

Mowers HyCut

£35250



The HyCut Mower features a true hybrid drive, with electric motors powering both the tracks and the blade. The intelligent motors act in tandem, slowing down the tracks if necessary to allow the blades to work through denser vegetation. This not only gives a more consistent cut, but also saves a lot of fuel. The machine can travel up to 1km without needing charging input from the engine. App integration allows you to track the vital stats of the mower in real time including motor temperature and voltages. It also allows for easy reporting of the mowers location, working hours and slope angles to improve usage efficiency. Software updates are able to be made remotely and over-the-air to keep your HyCut running smoothly.

Model Number	Hycut
Power plant	Hybrid
Range	1km Electrical power
Controller range	300m
Start	Electric start
Working width	1150mm
Cutting height	55mm - 180mm
Max angle	55°
Speed	0-6km/h forward/reverse
Weight	560kg

Track width	150mm
Engine	23hp Briggs & Stratton
Noise Levels	53dB (electrical) 78.6dB (hybrid drive)
Fuel tank	Removable marine style tank
Motors	2x 10.5kw air cooled planetary gear motors 1x 10kw blade motors
Emergency stop	On controller and machine
User interface	Remote control and web app



RCH-Series Roughcutter



The Roughcutter is the new generation of professional Flail Mowers for dense grass and vegetation mowing, combining power and simple controls for an effortless mowing experience. The Roughcutter is built with the operator in mind, with adjustable vibration dampened handlebars for maximum comfort, Infinitely variable hydraulic drive and low noise. The height of cut can be easily adjusted in 4 positions to suit different areas of operation and the type of cut can be changed, with different blades available for rough cutting and fine grass cutting. The Roughcutter is built for heavy commercial use, with different width options for narrow access, bank work and wide area mowing.

Model	1365	1680	18100
Cutting Width	65cm	80cm	100cm
Engine	13hp Briggs & Stratton 2 Cyl Petrol	16hp Briggs & Stratton 2 Cyl Petrol	18hp Briggs & Stratton 2 Cyl Petrol
Forward/Reverse Speed	0-6 Kmph with infinitely adjustable Hydrostatic drive	0-6 Kmph with infinitely adjustable Hydrostatic drive	0-6 Kmph with infinitely adjustable Hydrostatic drive
Height Adjustment	4 way adjustable	4 way adjustable	4 way adjustable
E-Start	No	Yes	Yes
Slope Capability	20°	30°	30°
UBS Hydro 0 Turn	Yes	Yes	Yes
Price (£)	8195	10695	11995



KERSTEN ROUGHCUTTER BANK MOWING

RIPAGREEN

The new generation of professional thermic hot air blowers has been invented by RIPAGREEN®. Its process forces high velocity hot air over the leaf of a plant.

This hot air instantly causes a thermal shock that breaks the chlorophyll producing part of the plant, the process of photosynthesis is prevented. The plant then dries naturally with a visible result after a few hours.

To effectively weed with RIPAGREEN®, it is not necessary to burn the plant, but only give it a hot shot (about 80 ° in the thickness of the leaf). The action is immediate, bringing a saving of time and consequent energy. The reserves of energy in the roots of the plant will determine how effective the treatment is. This treatment is therefore more effective on plants at seedling / young shoot stage. With a regular frequency of passage, the plant will be weakened until it is exhausted



RIPAGREEN THERMAL WEED MANAGEMENT PRODUCTS

Model

Specification

Contains

Easy



- Adjustable Heat Power 45-80KW
- Supplied by propane gas
- Gas consumption 2.9 to 5kg/h
- Standard lance net weight 2.10kg
- Trolley net weight 11kg

- Ripagreen Standard Lance
- Easy Bottle Carrying Trolley
- 4m Gas Hose
- Adjustable Gas Regulator
- Spare Piezo Igniter



Mobility



- Adjustable Heat Power 45-80KW
- Supplied by propane gas
- Gas consumption 2.9 to 5kg/h
- Mini lance net weight 1.96kg
- Harness net weight 2.5kg

- Ripagreen Mini Lance
- Mobility Kit Backpack
- 1m Gas Hose
- Adjustable Gas Regulator
- Spare Piezo Igniter



Easy +



- Adjustable Heat Power 45-80KW
- Supplied by propane gas
- Gas consumption 2.9 to 5kg/h
- Mini lance net weight 1.96kg
- Harness net weight 2.5kg
- Trolley net weight 11kg

- Ripagreen Mini Lance
- Mobility Kit Backpack
- Easy Bottle Carrying Trolley
- 4m & 1m Gas Hose
- Adjustable Gas Regulator
- Spare Piezo Igniter



Autonomy



- Adjustable Heat Power 45-80KW
- Supplied by propane gas
- Gas consumption 2.9 to 5kg/h
- Mini lance net weight 1.96kg
- Mounting frame net weight 33kg

- Ripagreen Mini Lance
- Vehicle Mounting Frame
- 15m Gas Hose Reel
- Adjustable Gas Regulator
- Spare Piezo Igniter



Ripagreen Easy Kit

£2195



Ergonomic lance

Adjustable gas regulator

Gas bottle trolley

Rotatable 30° diffuser

Large pneumatic tyres ideal for large obstacles such as rocks and kerbs

The Easy Kit is made up of an ergonomic trolley capable of carrying a 13kg (30 lbs) gas bottle, along with a thermal lance suited for “comfortable” weeding in push mode or “precision” weeding in carry mode. The various configurations possible, along with the power of the hot air stream, provide you optimum working comfort and unprecedented adaptability.

The RIPAGREEN® thermal lance has adjustable heating power. It diffuses the heat from a short and rigid flame through its stainless steel nozzle. It is designed for ergonomic use by a single operator either pushed to cover large areas quickly and effortlessly, or carried to deal with complex or isolated areas.

The stainless steel heat diffuser can rotate 360° and blows a steady ray of heat in order to guarantee precise weeding over an area 40 cm in width (16 inches). Its unique manufacturing design and quality materials make it extremely durable and long-lasting.

1 (341053) Ripagreen Mini thermal lance
92cm (US/BS norm) with :

- 4 m gas hose with crimped connectors
- 1 gas regulator adjustable 1.5-3.5 bar (22-51 psi)
- 1 spare igniter stored in the handle
- 1 wrench for connections + a user's guide

1 (333550) 1 Multimodal carrying trolley for gas cylinder:

- For 10 to 15 kg gas
- Textile bottle cover
- Adaptable push and pull handle operation
- Parking brake
- Support for standard lance

Technical data for Ripagreen Easy Kit:

- adjustable heat power from 45 to 80 kW
- supply: propane gas in gaseous phase
- gas consumption: 2.9 to 5.2 kg/h (6.4 - 11.5 lbs/h)
- Mini lance net weight: 1.96 kg (hose excluded)
- Trolley net weight: 11 kg (bottle excluded)



Ripagreen Mobility Kit

£1995



The Ripagreen Mobility Kit is a comfortable lightweight backpack system for treating weeds. The innovative Ripagreen® ergonomic harness accepts all types of “small” gas cylinders (5 to 6 kg propane). It offers optimal comfort with adjustable straps and swivel stainless steel arm at the front.

The RIPAGREEN® thermal lance has adjustable heating power. It diffuses the heat from a short and rigid flame through its stainless steel nozzle. It is designed for ergonomic use by a single operator either pushed to cover large areas quickly and effortlessly, or carried to deal with complex or isolated areas.

The stainless steel heat diffuser can rotate 360° and blows a steady ray of heat in order to guarantee precise weeding over an area 40 cm in width (16 inches). Its unique manufacturing design and quality materials make it extremely durable and long-lasting.

1 (341053) Ripagreen Mini thermal lance 92cm (US/BS norm) with :

- 4 m gas hose with crimped connectors
- 1 gas regulator adjustable 1.5-3.5 bar (22-51 psi)
- 1 spare igniter stored in the handle
- 1 wrench for connections + a user's guide

1 (341053) Ergonomic harness for thermal weed control lance and lightweight gas cylinder with:

- Textile bottle cover
- 1m gas hose with crimped connectors
- Lance support system

Technical data for Ripagreen Mobility Kit:

- adjustable heat power from 45 to 80 kW
- supply: propane gas in gaseous phase
- gas consumption: 2.9 to 5.2 kg/h (6.4 - 11.5 lbs/h)
- Mini lance net weight: 1.96 kg (hose excluded)
- Harness net weight: 2.45 kg (bottle excluded)



Ripagreen Easy + Kit

£2400



The Easy + Kit is made up of the trolley and lance from the Easy Kit, and the Ripagreen® ergonomic harness. This means you can enjoy the freedom of movement a 13kg (30 lbs) bottle provides, and still work with one hand. This allows you to cover larger areas with unparalleled levels of comfort.

The RIPAGREEN® thermal lance has adjustable heating power. It diffuses the heat from a short and rigid flame through its stainless steel nozzle. It is designed for ergonomic use by a single operator either pushed to cover large areas quickly and effortlessly, or carried to deal with complex or isolated areas.

The stainless steel heat diffuser can rotate 360° and blows a steady ray of heat in order to guarantee precise weeding over an area 40 cm in width (16 inches). Its unique manufacturing design and quality materials make it extremely durable and long-lasting.

1 (341053) Ripagreen Mini thermal lance
92cm (US/BS norm) with :

- 4 m gas hose with crimped connectors
- 1 gas regulator adjustable 1.5-3.5 bar (22-51 psi)
- 1 spare igniter stored in the handle
- 1 wrench for connections + a user's guide

1 (333550) 1 Multimodal carrying trolley for gas cylinder and Ergonomic Harness:

- Textile bottle cover
- 1m gas hose with crimped connectors
- Lance support system
- Adaptable push and pull handle operation
- Parking brake
- Support for standard lance

Technical data for Ripagreen Easy + Kit:

- adjustable heat power from 45 to 80 kW
- supply: propane gas in gaseous phase
- gas consumption: 2.9 to 5.2 kg/h (6.4 - 11.5 lbs/h)
- Mini lance net weight: 1.96 kg (hose excluded)
- Trolley net weight: 11 kg (bottle excluded)
- Harness net weight: 2.45 kg (bottle excluded)



Ripagreen Autonomy Kit £3095



Rotatable 30° diffuser

Adjustable gas regulator

Ergonomic lance

Bottle carrying bracket

40m hose reel

The Autonomy Kit features an adjustable support frame to keep the bottle(s) securely in place, an automatic 15m hose reel (49 ft), and a light, easy-to-handle mini lance. With this unit loaded onto your vehicle, your environmentally friendly weeding will know no limits.

The RIPAGREEN® thermal lance has adjustable heating power. It diffuses the heat from a short and rigid flame through its stainless steel nozzle. It is designed for ergonomic use by a single operator either pushed to cover large areas quickly and effortlessly, or carried to deal with complex or isolated areas. The stainless steel heat diffuser can rotate 360° and blows a steady ray of heat in order to guarantee precise weeding over an area 40 cm in width (16 inches). Its unique manufacturing design and quality materials make it extremely durable and long-lasting. Additional Universal Mounting frames can be purchased to add more gas cylinders to keep you going for longer periods.

1 (341053) Ripagreen Mini thermal lance
92cm (US/BS norm) with :

- 1 gas regulator adjustable 1.5-3.5 bar (22-51 psi)
- 1 spare igniter stored in the handle
- 1 wrench for connections + a user's guide

1 (333657) 1 Vehicle Mounting Frame for gas cylinder:

- 1 Cylinder securing strap
- For 10 to 15 kg gas
- Textile bottle cover
- 1 Thermal lance bracket with fasteners
- Automatic hose reel
- 15m hose with crimped connectors
- Vehicle mount clamping kit

Technical data for Ripagreen Autonomy Kit:

- adjustable heat power from 45 to 80 kW
- supply: propane gas in gaseous phase
- gas consumption: 2.9 to 5.2 kg/h (6.4 - 11.5 lbs/h)
- Mini lance net weight: 1.96 kg (hose excluded)
- Frame net weight: 33 kg (bottle excluded)



RIPAGREEN AUTONOMY KIT MOUNTED ON A UTILITY VEHICLE

HOAF **INFRARED**

Hoaf Weed Burners provide Pesticide free weed control for public spaces, footpaths, carparks and homes. The Hoaf Infra Plus System uses infrared radiation in combination with hot air. By exposing the unwanted vegetation to this process, the proteins in the weeds congeal and the moisture cells burst open at about 80°C. As a result the vegetation starts wilting and dies.

The design allows great access into tight areas and paths, but the working width of the unit is large enough for covering sizeable areas in a short time. Because the product relies on heat, it can be used in the wet; allowing your weed killing to be less weather dependent. The hood design makes it easy to get right up to obstacles and the low hood allows access under park benches and picnic tables.



HOAF THERMHIT 75

Model

Specification

Attachments

ThermHit 15



- Gas - Liquid Propane - (Gas off-take)
- Capacity - 11Kw. Gas Consumption - 0.8kg/hour
- Ignition Device - Piezo
- Working width - 150mm
- Weight - 4Kg
- Capacity per hour - 750m² @ 5kmh
- Adjustable gas pressure regulator.
- Burner protection shield.

- Gas Bottle Trolley



ThermHit 25



- Gas - Liquid Propane - (Gas off-take)
- Capacity - 20kw Gas Consumption - 1.5kg/hour
- Ignition Device - Piezo
- Working width - 250mm
- Weight - 11Kg
- Capacity per hour - 1250m² @ 5kmh
- Adjustable gas pressure regulator.
- Burner protection shield.

- Gas Bottle Trolley



ThermHit 45



- Gas - Liquid Propane - (gas off-take)
- Capacity - 35kw Gas Consumption - 2.5kg/hour
- Ignition Device - Piezo
- Working width - 450mm
- Weight - 25Kg
- Capacity per hour - 1350m² @ 5kmh
- Adjustable gas pressure regulator.
- Burner protection shield.



WeedAir



- Gas - Liquid Propane - (gas off-take)
- Capacity - 15kw Gas Consumption - 1.1kg/hour
- Ignition Device - Piezo
- Working width - 500mm & 750mm
- Weight - 40Kg
- Capacity per hour - 750m² - 1000m² @ 1.5kmh
- Adjustable gas pressure regulator.
- Burner protection shield.

- Bottle Holder



ThermHit 75



- Gas - Liquid Propane - (gas off-take)
- Capacity - 82kw Gas Consumption - 6.0kg/hour
- Ignition Device - Piezo
- Working width - 750mm
- Weight - 40Kg
- Capacity per hour - 2250m² @ 3kmh
- Adjustable gas pressure regulator.
- Burner protection shield.



ThermHit-Series ThermHit 15

£695



The HOAF thermHIT[®] 15 is ideally suited for burning small areas around the house and as a professional device for burning around street furniture. The HOAF thermHIT[®] 15 is equipped with an elbow support and an electro-mechanical igniter for ease of use. The HOAF thermHIT[®] 15 can also be connected to other HOAF weed burners.

The Hoaf thermHIT is ideal for burning weed on paths, paving and around obstacles. The gas consumption of the thermHIT 15 is around 0.8kg per hour. This can treat up to 750m² at a slow walking pace.

The HOAF pedestrian burners are balanced very well, which results in simple operation. The gas consumption can be adjusted using the gas control valve which results in gas efficient operation. Thanks to the low burner cover it is possible to easily burn under benches. The ThermHIT 15-25 uses Liquid Propane Gas bottles with gas off-take available from Calor Gas in 3.9kg, 6kg, 13kg. The optional bottle trolley makes light work of transporting the gas supply.

Model Number	HFTH015
Gas	Propane
Capacity	11Kw
Gas Consumption	0.8kg/hour
Ignition device	Piezo Igniter
Working width	150mm

Weight	4kg
Capacity per hour	750m ² @ 5km/h
Warranty	1 year
Additional features	
Adjustable gas pressure regulator	Yes
Burner protection shield	Yes



ThermHit-Series ThermHit 25



£995

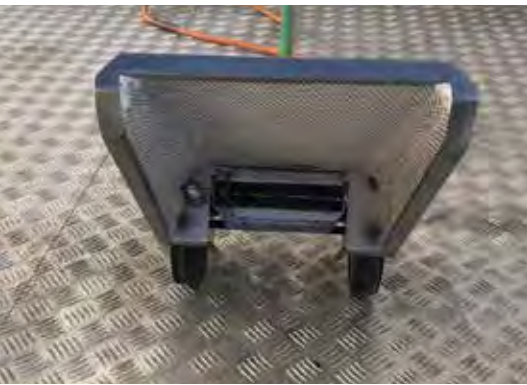

The power of the HOAF thermHIT[®] 25 is infinitely adjustable with the 10-step pressure regulator. The ability is therefore adjustable to the amount of weeds. To increase the ease of operation, the handle is adjustable in height and the burner is electromechanically ignited by means of a piezo igniter.

The Hoaf thermHIT is ideal for burning weed on paths, paving and around obstacles. The gas consumption of the thermHIT 25 is around 1.5kg per hour. This can treat up to 1250m² at a slow walking pace.

The HOAF pedestrian burners are balanced very well, which results in simple operation. The gas consumption can be adjusted using the gas control valve which results in gas efficient operation. Thanks to the low burner cover it is possible to easily burn under benches. The ThermHIT 15-25 uses Liquid Propane Gas bottles with gas off-take available from Calor Gas in 3.9kg, 6kg, 13kg. The optional bottle trolley makes light work of transporting the gas supply.

Model Number	HFTH025
Gas	Propane
Capacity	20Kw
Gas Consumption	1.4kg/hour
Ignition device	Piezo Igniter
Working width	250mm

Weight	11kg
Capacity per hour	1250m ² @ 5km/h
Warranty	1 year
Additional features	
Adjustable gas pressure regulator	Yes
Burner protection shield	Yes



ThermHit-Series ThermHit 45

£3195



The HOAF thermHIT[®] 45 stands out for its simplicity. Due to its compactness, this burner is multifunctional and perfect for burning around obstacles. The burner is suitable for treating small surfaces such as terraces, driveways, picnic areas. The low burner hood makes it possible to burn under benches. The HOAF thermHIT[®] 45 is well balanced and therefore easy to operate. The burner is ignited electrically.

The gas consumption of the thermHIT 45 is around 2.5kg per hour. This can treat up to 1350m² at a slow walking pace.

The HOAF pedestrian burners are balanced very well, which results in simple operation. The gas consumption can be adjusted using the gas control valve which results in gas efficient operation. Thanks to the low burner cover it is possible to easily burn under benches. The ThermHIT 45 uses Propane Gas bottles with gas off-take available from Calor Gas in 13kgs. The bottle trolley is built into the machine, which makes light work of transporting the gas supply.

Model Number	HFTH045
Gas	Propane
Capacity	35Kw
Gas Consumption	2.5kg/hour
Ignition device	Piezo Igniter
Working width	450mm

Weight	25kg
Capacity per hour	1350m ² @ 5km/h
Warranty	1 year
Additional features	
Adjustable gas pressure regulator	Yes
Burner protection shield	Yes



Weedair-Series Weedair



The HOAF WeedAir® uses heated air to control unwanted vegetation on all types of paved and unpaved surfaces. A powerful air flow is evenly distributed under the insulated hood. By exposing the plant to this heat, the proteins in the weeds congeal and the moisture cells burst open. As a result the vegetation starts to wilt and die. .

The compact and lightweight design make the HOAF WeedAir® comfortable to operate on various surfaces. The large wheels reduce the effort required to travel on pavements, kerbs and unpaved paths. The handle bar is easily adjustable with 3 height settings to suit different operators. A simple one touch ignition starts the HOAF WeedAir®. The working temperature is indicated on a digital display powered by a rechargeable battery. A battery charger is included. A stainless steel hood containing the heated air is fully enclosed and insulated all around, allowing minimal heat loss and increasing the efficiency of the fuel.

Model Number	Price (£)	Capacity	Consumption	Weight	Burners	Width
HF20000477 Weedair 50 i	2495	15Kw	1.1kg/hour	40kg	1	50cm
HF20000478 Weedair 75 i	3995	30Kw	2.2kg/hour	45kg	2	75cm



HOAF WEEDAIR 50I

ThermHit-Series ThermHit 75

£3895



Gas control handle

Liquid propane gas bottle

Electronic ignition

Gas bottle carrying tray

Large pneumatic tyres ideal for large obstacles such as rocks and kerbs

Infrared shield

The HOAF thermHIT[®] 75 is the largest hand burner in the HOAF thermHIT[®] series. With a working width of 750 mm, this burner is very suitable for keeping larger areas such as squares, walking routes, bicycle paths and the like free of weeds. Despite the large working width, the HOAF thermHIT[®] 75 continues to move easily thanks to the robust wheels. The burner is ignited electrically by means of a battery igniter.

The Hoaf thermHIT is ideal for burning weed on paths, paving and around obstacles. The gas consumption of the thermHIT 75 is around 6kg per hour. This can treat up to 2250m² at a slow walking pace.

The HOAF pedestrian burners are balanced very well, which results in simple operation. The gas consumption can be adjusted using the gas control valve which results in gas efficient operation. Thanks to the low burner cover it is possible to easily burn under benches. The ThermHIT 75 uses Liquid Propane Gas bottles with liquid take-off available from Calor Gas in 12kgs. supply.

Model Number	HFTH075
Gas	Propane
Capacity	82Kw
Gas Consumption	6kg/hour
Ignition device	Piezo Igniter
Working width	750mm

Weight	40kg
Capacity per hour	2250m ² @ 3km/h
Warranty	1 year
Additional features	
Adjustable gas pressure regulator	Yes
Burner protection shield	Yes



Weedgo®!

The WeedGo! kits attach directly to your brushcutter or strimmer and allow you to turn it into a weedbrush for clearing moss on hard surfaces such as tarmac or block paving.

The WeedGo! is designed for removal in smaller areas and around tricky obstacles like benches or railings, which are difficult to access with a larger weedbrush. It is really easy to carry as an extra tool with your brushcutter, taking up little extra space.

We have models that are suitable for most major brands of brushcutter and strimmer from 1.36hp + including popular Stihl, Husqvarna and Echo models. The weedbrush is extremely easy to operate, but should be used in conjunction with a harness, guard and other PPE at all times.



Model

Specification

Attachments

Weedgo 2



Weedgo Head for 20mm or 25.4mm
trimmer head connection

4 x Brushes

Adapter for straight shaft

Protective brush guard for contain-
ment of debris

Requires Minimum of 1.4hp to operate

- Stihl KM94
- Brushcutter with 26mm shaft
- Brushcutter with 28mm shaft
(minimum of 1.4hp)



Weedgo Pro



Weedgo Head for 26mm or 28mm
trimmer head connection

6 x Brushes

Adapter for straight shaft

Protective brush guard for contain-
ment of debris

Requires Minimum of 1.4hp to ope-
rate

- Stihl FS360 - FS 460
- Echo SRM420 TES
- Echo SRM 520 ES
- Husqvarna 555
- Husqvarna 553
- Husqvarna 545



WeedGo-series Weedgo 2

£365



Debris guard



Weedgo brush head



Weedgo 2 steel brush



The Weedgo! Two is a weedbrush attachment that fits to your brushcutter or strimmer. The weedbrush allows clearance of moss and weeds from hard surfaces such as tarmac or block paving.

Operating the machine is similar to normal use with a strimming line, except the brush is kept in contact with the ground the whole time. When up to full speed it is very simple to control and lifts the moss with relative ease.

The Weedgo Two features two replaceable brushes that can be released and replaced without tools.

It is advisable to use the brush for smaller tasks and away from windows etc, as the head is spinning very fast and can throw stones.

Steel or Nylon brushes are available

This machine will fit the following models of brush cutter

- Sthil KM94
- Brushcutter with 26mm shaft
- Brushcutter with 28mm shaft
(minimum of 1.4hp)

Part Number	Description	Price(£)
WGB660-8	Replacement Steel Brushes (pack of 8)	45
WGB660N-8	Replacement Nylon Brushes (pack of 8)	54



Weedgo-series Weedgo Pro

£395

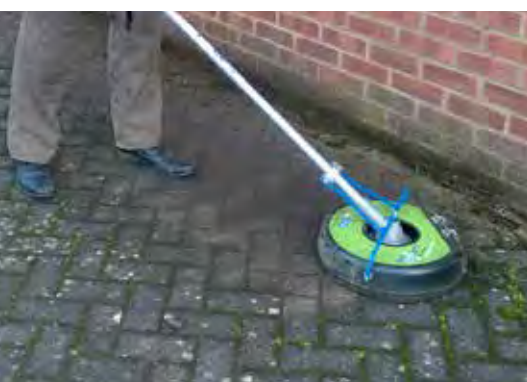
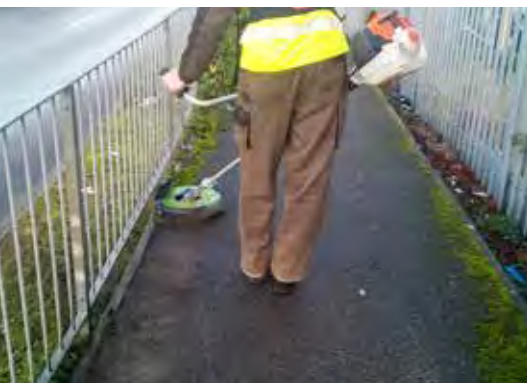

Debris guard

Weedgo brush head



Weedgo pro steel brush



Weedgo brush changing tool

The Weedgo! Pro is a weedbrush attachment that fits to your brushcutter or strimmer. The weedbrush allows clearance of moss and weeds from hard surfaces such as tarmac or block paving.

Operating the machine is similar to normal use with a strimming line, except the brush is kept in contact with the ground the whole time. When up to full speed it is very simple to control and lifts the moss with relative ease.

It is advisable to use the brush for smaller tasks and away from windows etc, as the head is spinning very fast and can throw stones.

The Weedgo Pro Features three replaceable brushes that can be changed in a few seconds with the tool provided in the kit. Steel or Nylon brushes are available

This machine will fit the following models of brush cutter

- Stihl FS360 - FS 460
- Echo SRM420 TES
- Echo SRM 520 ES
- Husqvarna 555
- Husqvarna 553
- Husqvarna 545

Part Number	Description	Price(£)
WG511012	Replacement Steel Brushes (pack of 12)	45
WG511012N	Replacement Nylon Brushes (pack of 12)	59



WEEDGO PRO

Kersten

SITE MAINTENANCE EQUIPMENT

**KERSTEN (UK) LTD
PROGRESS HOUSE
39 BOULTON ROAD
READING
RG2 0NH**

**0118 986 9253
INFO@KERSTENUK.COM**